

STOBAG



CAMABOX

Cassette awning in a modern cubic design.



CAMABOX BX4000 | BX4700



Attractive cassette awning in cubic design



BX4700 with integrated Tunable White LED lighting

CAMABOX – product benefits

- Cassette awning for shading medium to large areas
- Contemporary, cubic design
- Awning box protects the fabric and articulated arms from the elements when closed
- Integrated tilt joint ensures that the box closes perfectly
- Various mounting options: on the wall, under the ceiling or on the rafters (depending on the model)
- Flexible mounting options thanks to variable bracket positioning
- Awning inclination adjustable from 5° to 35°
- Optional wall connection profile for a direct, flush transition from facade to box

Technical dimensions in millimetres

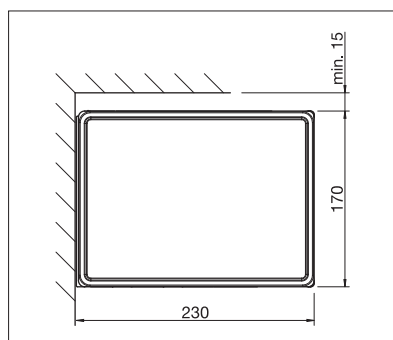

Wall installation

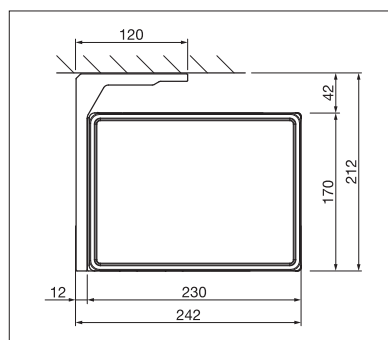

Top installation

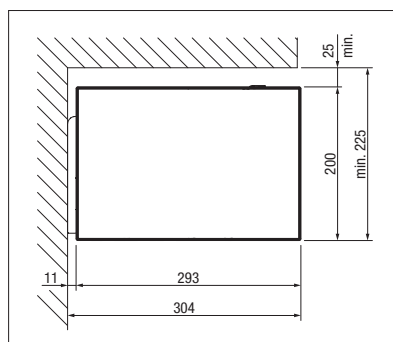

Wall installation

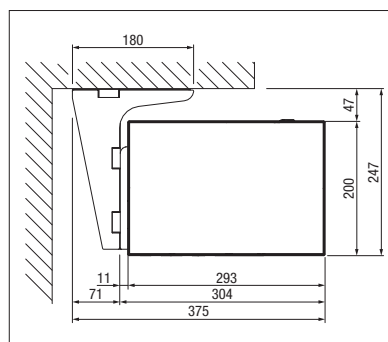

Top installation



COLORS

Discover the diverse options when selecting frame colours.



Integrated LED lighting in the box



BX4700 electronic Volant-Plus valance with Tunable White LED lighting on the front rail

BX4000



reddot award 2017 winner

- Reduced, minimalist design
- Winner of the Red Dot Award 2017
- Winner of the German Design Award 2019



BX4700

New, high-quality premium design:

- Clearly defined lines and edges
- Magnetic locking technology on the side of the box ensures there are no visible screws and guarantees easy servicing
- Winner of the IF Design Award 2023, German Design Award 2023, and Red Dot Design 2023 for "excellent product design" and "stylish elegance"



Optional features:

- Mounting on rafters with optional rafter brackets
- Integrated dimmable LED lighting in the box
- Drive via electric motor as standard; on request also available with manually operated hand crank



reddot winner 2022

Optional features:

- Motorized lowerable Volant-Plus valance for low sun and extra privacy
- Tunable White: dimmable LED lighting, infinitely variable from cool to warm white, integrated in the box and/or front rail
- No visible screws when ceiling-mounted thanks to the attractively designed cover



min. 214 cm
max. 600 cm



min. 150 cm
max. 300 cm



* The wind resistance class can vary depending on version and dimension.



min. 215 cm
max. 700 cm



min. 150 cm
max. 400 cm



* The wind resistance class can vary depending on version and dimension.



FABRICS

Choose from a comprehensive range of materials and colours.



ELECTRICS

More convenience thanks to the automated control and lighting systems.



**MODERN DESIGN FOR
SOPHISTICATED ARCHITECTURE.**