

S T O B A G

Stylish shade

Awnings for your home

Contents

Preface	2
STOBAG	4
Find the right awning	10
Open awnings	16
Box awnings	38
Pergola awnings	52
Freestanding awnings	60
Side shades	68
Conservatory shading	72
Hospitality and commercial	86
Frame colours	96
Fabric	100
Automation and control	102
Contact and locations	106
Key	108

Our awnings create more than just shade – they create moments. With Swiss precision and timeless design, we transform your outdoor space into an oasis of comfort and joie de vivre.



Dear Customers

For over 60 years, our vision has been clear: to elevate outdoor living through comfort and enduring beauty. What began with the idea of simplifying sunblind installation has evolved into a success story spanning three generations – underpinned by Swiss precision, innovation and passion.

Whether for the balcony, the patio or large hospitality venues – our awnings are as unique as your needs. They can be installed in a number of ways and blend in harmoniously with the overall look of your building. Thanks to a wide range of models, comfort options, frame colours and high-quality fabrics, they adapt perfectly to your needs and your style. Each solution is custom-crafted with precision, combining comfort, design and durability.

As the grandson of our founder, carrying these values forward is a matter close to my heart. Our vision remains unchanged: to create products that inspire as well as protect – based on quality, design and innovation. We thank you for the trust you have placed in us and look forward to creating living spaces with you – spaces that bring people, ideas and moments together.

Alain Michel
Group CEO and
Member of the Board of Directors,
STOBAG AG



The best solutions for every aspect of life: a privacy screen for the balcony, shading for panoramic windows or glass roofs, or the perfect patio solution. You can explore every facet of our diverse product portfolio in our showrooms.

Since starting out in 1964, we have been continually developing shading and weatherproofing solutions that create a seamless link between architecture and nature.



For over 60 years, STOBAG – an acronym derived from «Storen Bau Gattikon» (shutter/blind construction in Gattikon) – has stood for quality, progress and a passion for making outdoor living more attractive. What was once a small workshop has evolved into a globally operating family business with 750 employees worldwide, 350 of whom work at the headquarters in Muri, Aargau.

Under the leadership of our CEO Alain Michel, we are continuing the success story into the family's third generation by combining tradition with modern technology and setting new standards in design and comfort, always with a clear aspiration: to create harmony between architecture and nature – and to develop solutions that inspire generations.



Design with a heritage

For us, Swiss design means clean lines, premium quality and intelligent functionality. Innovation is in our DNA. From the revolutionary Trilliant telescopic-arm technology and modular awnings to modern glass roofs that expand the living space into the outdoors – we are continually setting new standards. With great attention to detail, we design products that not only offer protection but also provide inspiration – making your home a cosy and inviting place to stay.



Responsible manufacturing

We manufacture our products at four locations in Switzerland, Europe and Canada – using raw materials almost exclusively sourced from long-standing European partners. Here, state-of-the-art production meets precision craftsmanship – to create solutions that inspire on the strength of their design, functionality and durability. Sustainability is at the heart of what we do: short supply chains, carefully chosen materials, robust designs, repairability and recyclability.



Strong partnerships

We are committed to delivering exceptional service and expert guidance you can rely on – with a personal touch. We work with over 500 specialist partners in Switzerland and more than 1,000 worldwide – so we are always close to our customers and able to provide personalised advice and support. We take pride in nurturing long-term partnerships founded on trust, some of which have lasted for generations.



Every product a one-off

Our custom shading solutions are as unique as the way you choose to live outdoors. We offer a wide range of fully customised models, colours and comfort options that blend in harmoniously with any surroundings. Robust materials and precise workmanship ensure long-lasting enjoyment and sustainable use. Our shading solutions are perfectly tailored to your needs and your style, offering you protection and comfort for many years to come.



Find inspiration

Our 2000 m² rooftop showroom – open, stylish and full of possibilities – invites you to discover new living spaces. Immerse yourself in a living showcase of garden design and functionality, surrounded by water, light and flourishing plants. Our diverse range of products demonstrates how indoor living spaces can seamlessly flow into the outdoors. Outdoor furniture and a contemporary outdoor kitchen add inspiring highlights, bringing the perfect harmony of architecture and nature to life. This creates a space where ideas grow – and your personal retreat begins.



We make living spaces more valuable together. STOBAG awnings transform your outdoor space into an oasis of comfort and style – perfectly matched to your patio, balcony or garden. Our solutions combine design and functionality, creating outdoor spaces that give enduring pleasure.

1 Patio
For large outdoor spaces, we offer awnings that combine exceptional stability with the utmost elegance. They provide generous shade and create a cosy atmosphere – and are also ideal for making café and restaurant terraces welcoming places to be.

2 Penthouse terrace
Penthouse apartments are light and spacious. Shading provides effective sun protection here, enabling these spaces to be enjoyed in comfort even in bright sunlight. Whether facade-mounted or freestanding, our solutions are perfect for exposed locations thanks to their exceptional wind stability.

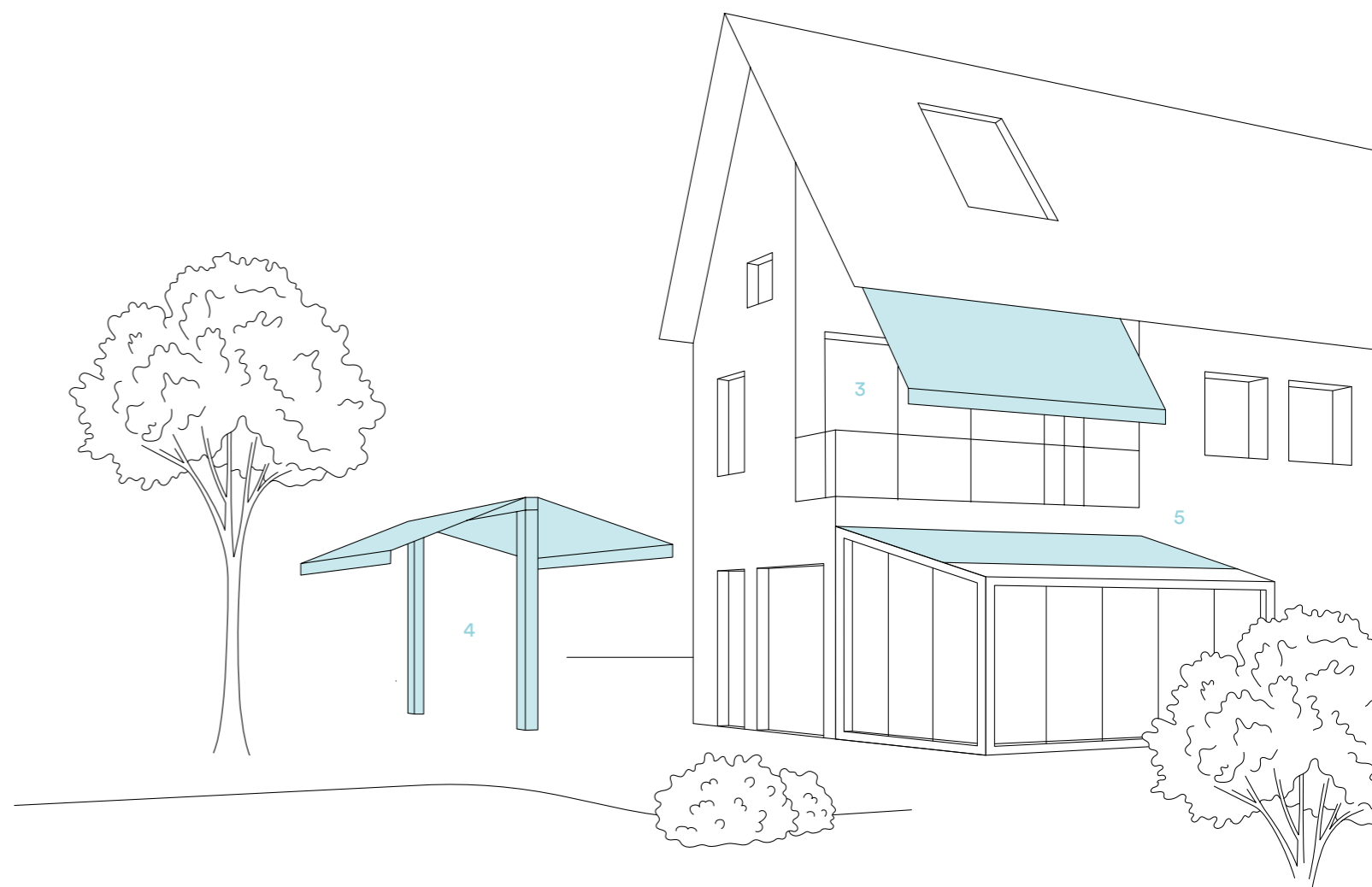
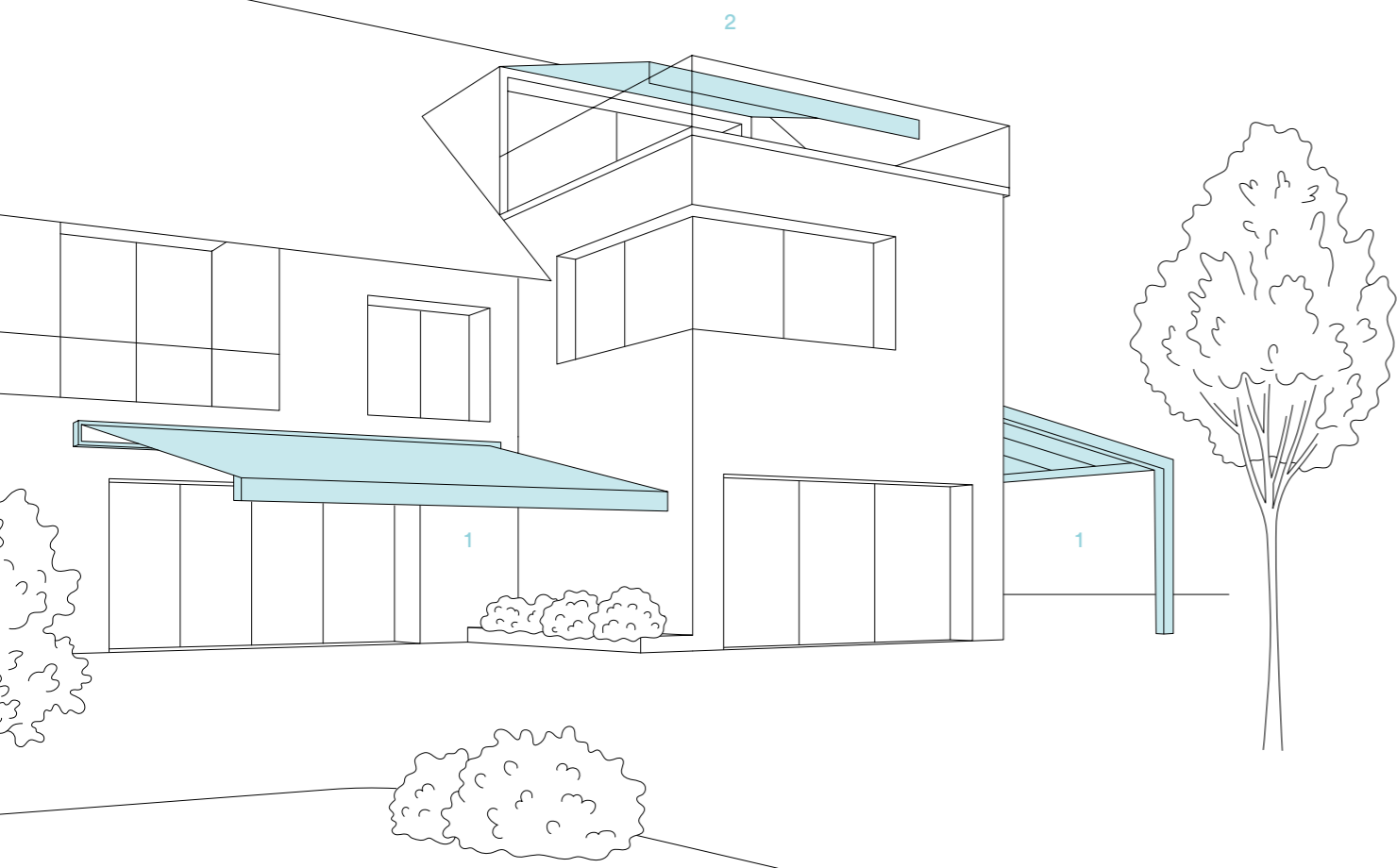

3 Balcony/loggia
Balconies and loggias expand your living space into the open air. Awnings create comfortable shade and a stylish atmosphere – perfectly tailored to your needs and your style. Thanks to flexible installation options, our solutions are easy to fit in even the most challenging architectural settings.

4 Garden
An awning creates pleasant shade and a stylish ambience in your favourite spot. Be it in the classic style mounted on the facade or as a freestanding structure in the garden, our awnings provide protection wherever you need it, creating space for relaxation or friendly get-togethers – perfect for any time of day.

5 Conservatory
Conservatories are bright havens of retreat. Our shading systems keep your conservatory comfortable all year round, efficiently regulating the temperature so you can enjoy every season there, including the summer.

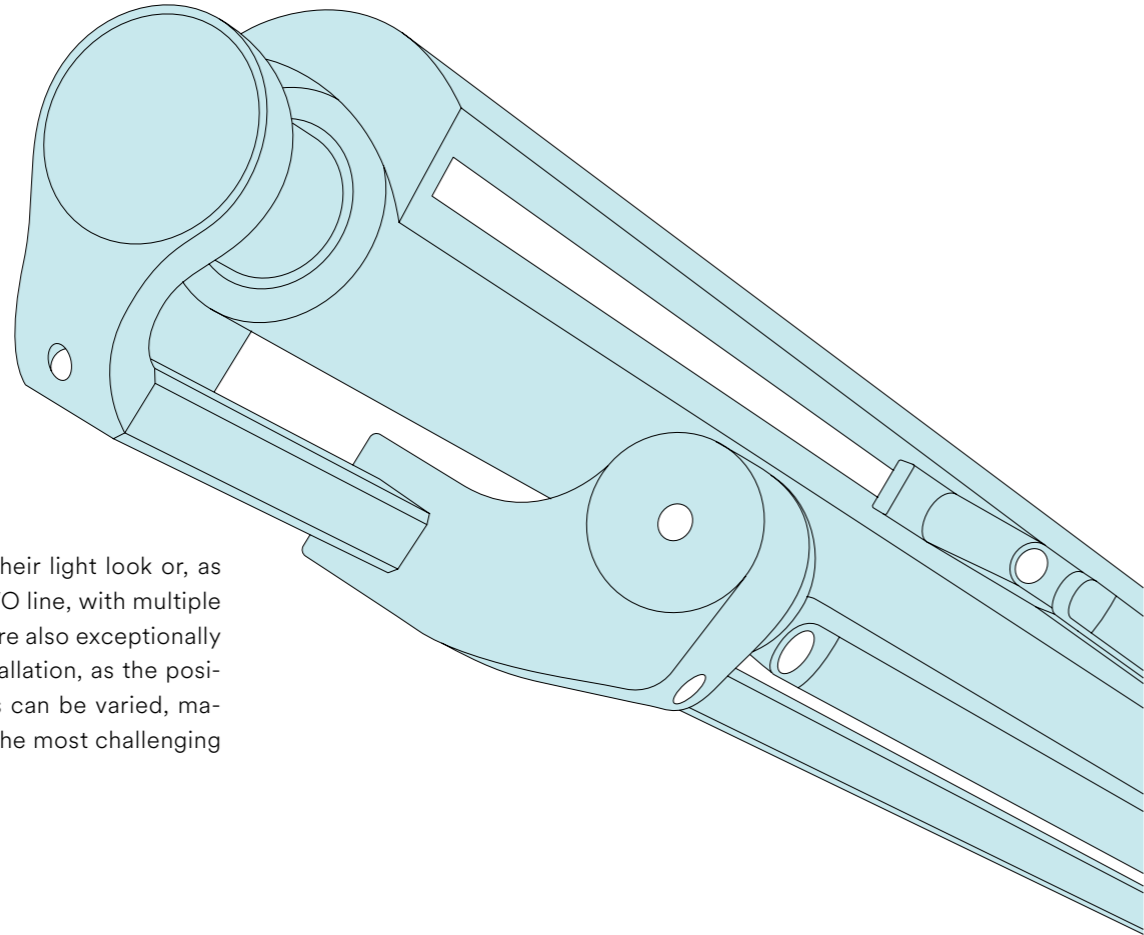

Design and protective box

Open awnings impress with their light look or, as in the case of the modular VIVO line, with multiple customisation options. They are also exceptionally flexible when it comes to installation, as the position of the mounting brackets can be varied, making them adaptable to even the most challenging architectural settings.

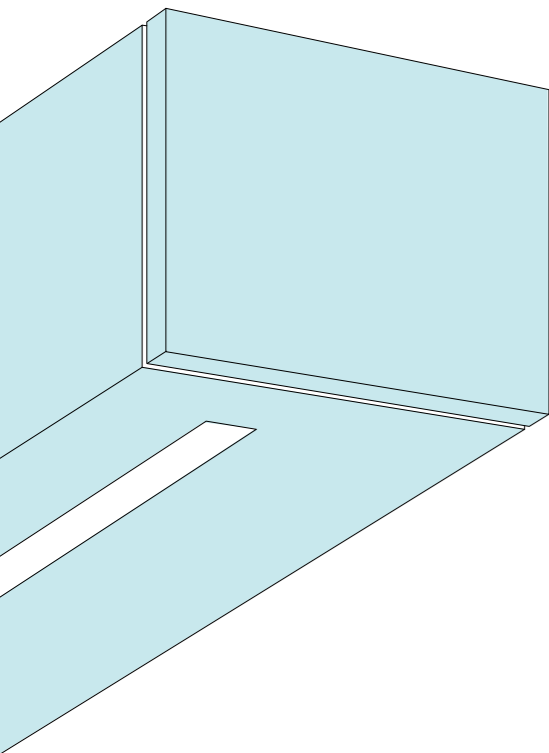

Box awnings are reliably shielded from the weather and dirt thanks to their protective box – keeping them looking good and working perfectly for longer. Certain models allow cables and plugs to be hidden away – for a seamless, high-end look. Box awnings are available in round or cubic form and blend in harmoniously with any architectural style.

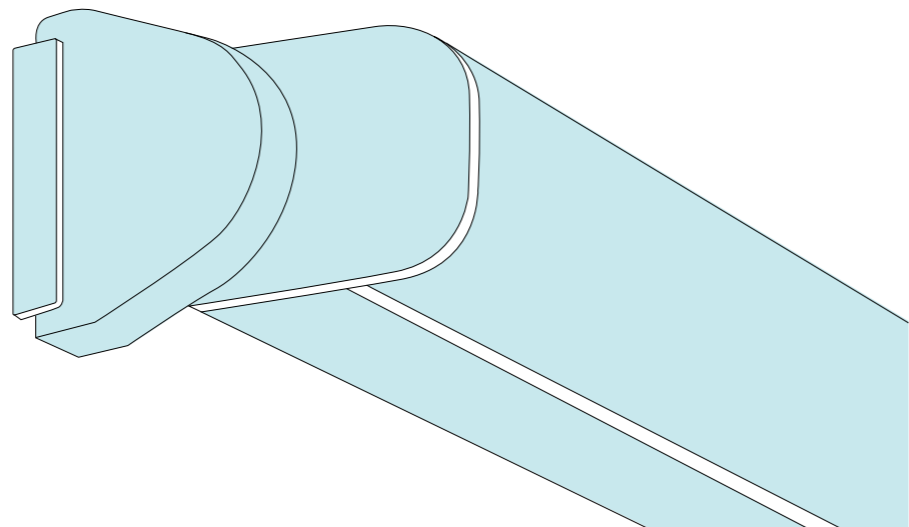

Size and dimensions

Be it for small balconies or large patios – reliable shade, the awning should be larger than the furniture area – ideally twice as deep and much wider – so as to create a comfortable retreat, even on hot days. Choosing the right awning size makes your outdoor space more comfortable and more versatile. To be sure of a harmonious overall look and

	Smaller area	Medium-sized area	Large area	Very large area
PROJECTION ← min. 150 cm up to max. 500 cm (depending on model)	VIVO AZUR SELECT PURABOX	VIVO AZUR SELECT CASABOX CAMABOX	VIVO SELECT TENDABOX CAMABOX	VIVO JUMBO RESOBOX
WIDTH →	min. 170 cm	up to max. 1800 cm (depending on model)		

Your awning – as unique as the way you live

Your outdoor space becomes a favourite spot – thanks to a variety of models, colours and clever comfort options. Be it robust folding arms or the exclusive Trilliant telescopic arms – STOBAG offers custom solutions that combine stability and design. Enhance your awning with atmospheric lighting, smart control or a Lowerable Volant-Plus – a drop valance that provides shade from the low-lying sun.

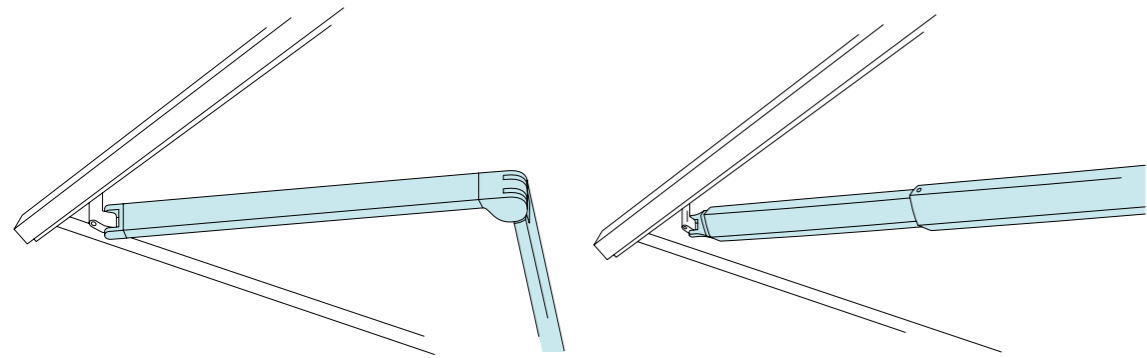

Awnings with folding arms

Folding arms are at the heart of all classic awnings. They ensure smooth extension and uniform fabric tension, no matter how wide the awning. Thanks to their precise construction, these awnings offer you exceptional stability and durability, combined with timeless design.

Awning with telescopic arms

The exclusive telescopic arms are a STOBAG innovation – and a world first. They guarantee maximum stability and perfect fabric tension. The linear extension movement makes your awning a joy to use.

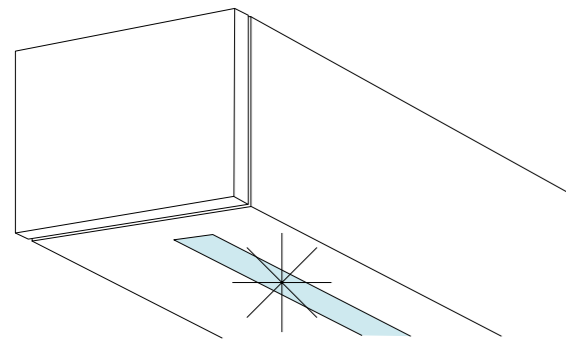

Light

Atmospheric lighting allows you to keep using your patio until well into the evening. The Tunable White enables smooth control of the colour temperature – from invigorating cool white to soft warm white – as and when you need. And a dimmer function lets you adjust the intensity of the light to create just the right mood.

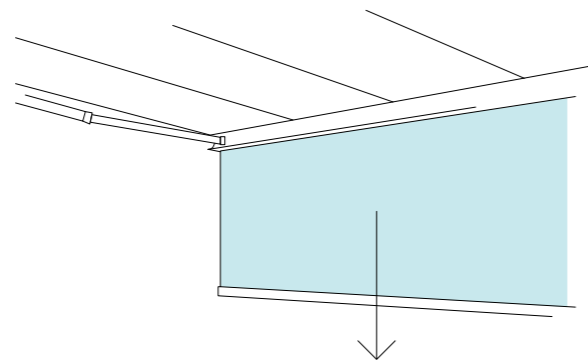

Lowerable Volant-Plus

This drop valance shields you from low-lying sun and breezes. Depending on your chosen fabric – transparent or opaque – you can enjoy an unobstructed view of the outside or maximum privacy, giving your outdoor space a feeling of comfort and security at all times.

Find your STOBAG awning

	Open awnings				Box awnings				
	VIVO	AZUR	SELECT	JUMBO	PURABOX	CASABOX	TENDABOX	CAMABOX	RESOBX
SMALLER AREA	✓	✓	✓	–	✓	–	–	–	–
MEDIUM-SIZED AREA	✓	✓	✓	–	–	✓	–	✓	–
LARGE AREA	✓	–	✓	–	–	–	✓	✓	–
VERY LARGE AREA	✓	–	–	✓	–	–	–	–	✓
ROUND DESIGN	✓	–	–	–	✓	✓	✓	–	✓
CUBIC DESIGN	–	–	–	–	–	–	✓	✓	–
FOLDING ARMS	✓	✓	✓	✓	✓	✓	✓	✓	✓
TELESCOPIC ARMS	✓	–	–	✓	–	–	–	–	–
LIGHT*	✓	–	–	–	–	–	–	✓	–
VALANCE*	✓	✓	✓	✓	–	–	–	–	–
LOWERABLE VOLANT-PLUS*	✓	–	✓	–	–	–	✓	✓	✓
RETROFIT COMFORT OPTIONS*	✓	–	–	–	–	–	–	–	–

* The application options depend on the product configuration. Our team of advisors will be happy to help you find the ideal solution.



VIVO

Modular awnings for luxury outdoor living.

Expand your living room into the outdoors and savour precious moments under the open sky. VIVO adapts to your needs – be it for small balconies or large patios – impressing with its sophisticated design and compact, timeless design language. Linear surfaces and the harmonious integration of every component create a flowing overall look. Thanks to its modular design, VIVO is fully customisable and easily expandable in the future. A wide range of frame and fabric colours, patterns, and optional functions afford you maximum design freedom. VIVO is a durable, high-quality awning ready to meet your requirements – an investment in comfort, protection and the value of your living space.

VIVO combines functionality, design and comfort – and adapts flexibly to your life. Your VIVO awning is fully customisable and grows with your needs. Even after purchasing your awning, you can add suitable comfort options as and when you wish.



Robust and durable.

Forged components for folding arms and telescopic arms represent resilience and precision. The GORE® Tenara sewing thread makes the fabrics extremely resistant. VIVO awnings stand for high-quality materials and enduring aesthetics.

Individual and versatile.

From arm technologies to comfort options to the fabric colour – design your awning exactly the way you want it, with the freedom to upgrade or expand whenever you choose. VIVO is flexible, functional and stylish – designed for today, built for tomorrow. For maximum freedom when designing your outdoor space.

Timeless and exquisite.

Experience state-of-the-art technology perfectly integrated into a compact design. The clean lines exude exceptional stability and dynamism. Linear surfaces and the harmonious integration of every component create a serene overall look that fits in perfectly with your home.

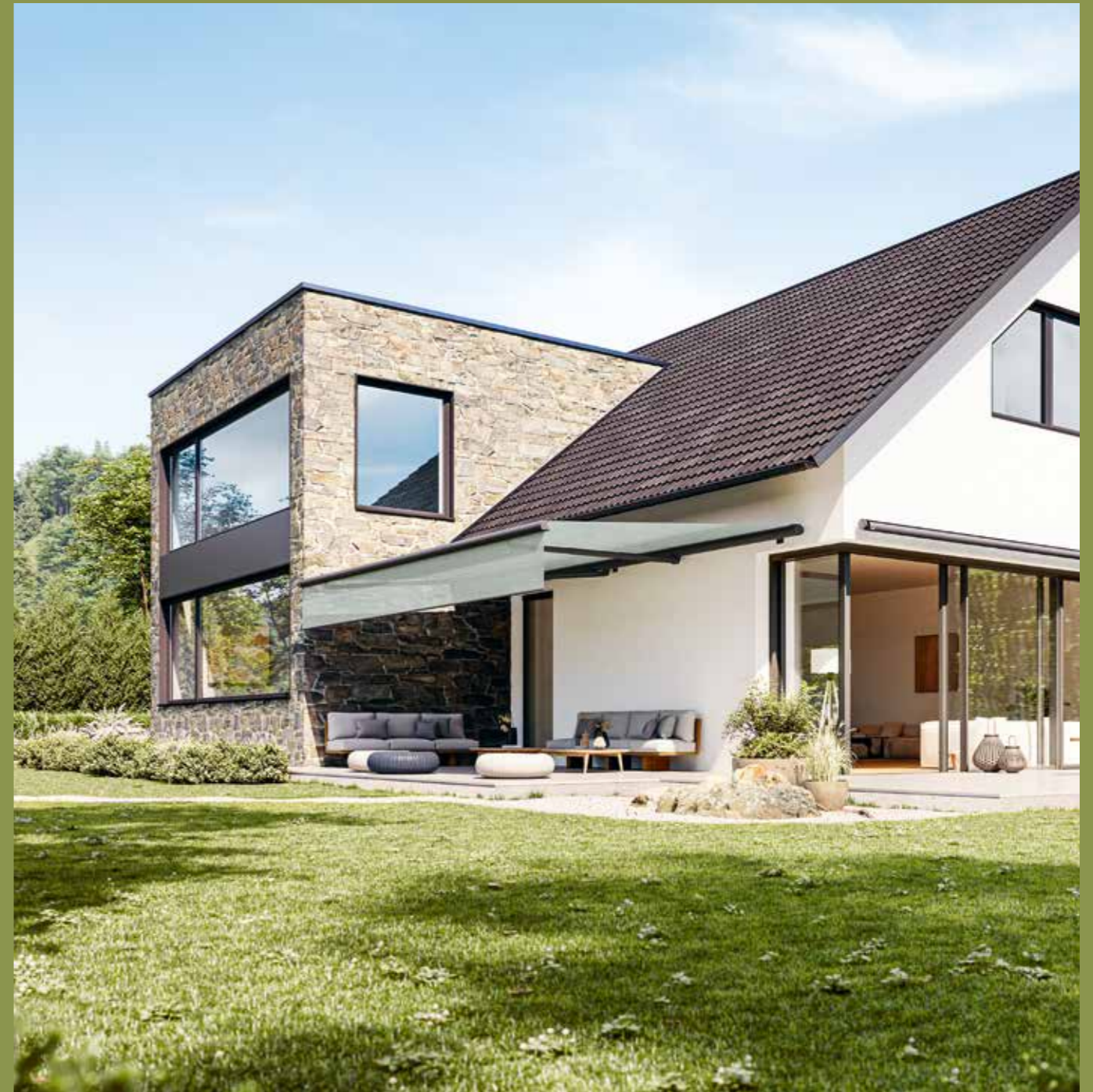

VIVO blends harmoniously into any environment – be it on the balcony, on the patio or in the seated area of your garden. The clean design language, combined with a wide range of colours and patterns, lets you create a look that perfectly reflects your personal style. VIVO is more than just sun protection – it’s an architectural statement of stylish outdoor living.

 All the technical details are listed for you on page 34

Trilliant telescopic arms – exclusive technology for perfect fabric tension.



VIVO with Trilliant telescopic arms is an innovation in the awning market. A world first, these arms not only offer exceptional stability; but also serve as aesthetic, design-defining elements for high-end architecture. Thanks to their unique form, the Trilliant telescopic arms have a slender look

and, when combined with Back-Impulse Technology, ensure excellent fabric tension. The linear movements of the Trilliant telescopic arms make extending the VIVO awning a moment to enjoy.



VIVO animation
Be inspired.



VIVO awnings are durable and modern. Because needs change over time, VIVO has been designed as a modular and expandable system. With VIVO, you're investing not only in comfort and protection, but also in the value of your living space.



Elegant protection for fabric and facade.

An optionally available top board reliably protects the fabric from rain, sun and dirt, while a wall connection profile prevents dirt streaks on the facade. At the same time, the top board lends the construction an elegant touch and ensures a harmonious overall look – functional yet stylish.



Protective sleeve – ingenious protection with a slimline look.

The protective sleeve reliably shields the retracted fabric from weather effects and dirt, while built-in drainage channels direct rainwater away from the awning. The result is a clean look with durable functionality – and a design that blends seamlessly into any architecture.



Valance – a stylish detail with a big impact.

The valance elegantly conceals the structure, protects the arms from weather effects and allows a lower awning inclination angle, affording you a better view and more clearance – not to mention extra protection from the low-lying sun.



The optional **drop valance** shields you from low-lying sun and breezes whenever you need it. Depending on the fabric you choose – transparent or opaque – you can enjoy pleasant light with an unobstructed view of the outside or maximum privacy. For more protection and a greater feeling of security.

 All the technical details are listed for you on page 34



Enjoy your favourite outdoor spot even after sunset – thanks to VIVO LED lighting. It creates an atmospheric mood and makes your outdoor space usable until late in the evening. What's more, it can be conveniently controlled using a hand-held transmitter or by incorporating it into a smart-home system.

**Glare-free light at the front**

The front lighting is elegantly integrated in the front bar and ensures uniform, glare-free illumination of the outdoor space. Light is emitted indirectly with a soft, diffused glow that's exceptionally gentle on the eyes, creating high-quality lighting that visually enhances your outdoor space and stylishly accentuates your architecture.

**Flexibly adjustable light at the rear**

The rear lighting is mounted directly on the mounting bar and gives you maximum flexibility. Adjustable light orientation allows for precise alignment during installation – to deliver light exactly where it's needed. A wide beam angle ensures soft, diffuse lighting – even with the awning fully closed. Be it a quiet book in the evening, a cosy get-together or simply for enjoyment – the right lighting makes your outdoor space a favourite spot even after dark.



VIVO HIDE

**Perfectly integrated.
Permanently impressive.**

VIVO Hide stands for uncompromising integration and architectural clarity. This built-in awning has been specially developed for narrow alcoves and can be integrated into plans for a new building as well as renovations. When retracted, the awning disappears completely into the building envelope, creating a sleek, uncluttered look. Clean lines and a minimalist design ensure seamless harmony between function and architecture. For an even more bespoke touch, the front bar can be fitted with a screen that blends in with the facade, making the sun protection virtually invisible. VIVO Hide combines lasting STOBAG quality with impeccable design – for those looking to elevate their home with style and purpose.



AZUR

Reliable protection. Compact design.

AZUR is the right choice for those seeking a straightforward, functional awning backed by STOBAG's proven quality. As an open folding-arm awning, it offers reliable sun protection for balconies and patios. The robust mounting bar ensures stability – even for a width of up to 7 metres. AZUR impresses with its compact design, solid technology and versatile installation options: it can be easily installed on the wall, ceiling or rafters. For additional protection, the awning can be optionally equipped with a top board – ideal for exposed locations. For a solution that fits perfectly.



SELECT

Functional sun protection for any size of space.

The SELECT awning is a talented all-rounder suitable for both small and large spaces. Its mounting-bar construction allows flexible installation on the wall, ceiling or rafters. Options include a Lowerable Volant-Plus valance for extra privacy and glare protection as well as a top board that shields both the fabric and the mechanism. With a SELECT awning, you are choosing functional sun protection with a range of optional features – simple, versatile and built to last.

The SELECT awning combines versatility with comfort. Designed to fit almost any space, it offers flexible installation options. Featuring smart innovations such as Ombramatic and the Lowerable Volant-Plus, it provides customised sun protection, enhanced privacy and a welcoming ambience.



Ombramatic – flexible adjustment of the awning inclination angle

The sun's position – and therefore also the shade – changes throughout the course of the year. The Ombramatic function lets you alter the slope on your awning to any angle up to 60°, giving you optimum protection from the sun and glare all year round. A hand crank allows easy adjustment – a simple and convenient solution.



Lowerable Volant-Plus

Designed for comfort, this drop valance shields you from low sun and adds a warm, cosy touch. It can be flexibly lowered to provide protection from glare and breezes. Depending on the fabric you choose – transparent or opaque – you can enjoy either an unobstructed view of the outside in pleasant light or maximum privacy. This keeps your outdoor space open yet protected – for relaxing moments at any time of day.



Product	VIVO S6600/S6800	VIVO S6800/P Protect	VIVO S6600/H Hide
Open awnings	Yes	Yes	Yes
Box awnings	–	–	–
Award-winning design	Yes	Yes	–
Maximum dimensions Width x projection	1800 x 400 cm	600 x 400 cm	700 x 400 cm
Installation on wall	Yes	Yes	Yes
Installation under ceiling	Yes	Yes	No
Installation on rafters	Yes	Yes	No
Installation in alcove	–	–	Yes
Maximum slope	0°–60°	0°–45°	0°–25°
Manual slope adjustment	–	–	–
Folding arms	Yes	Yes	Yes
Telescopic arms	Yes	Yes	–
Semi-cassette (fabric protection)	Yes (see Protect)	Yes	–
Top board	Yes	Yes	–
Valance	Yes	Yes	–
Light at front	Yes (up to max. 700 cm width)	Yes	–
Light at rear	Yes (up to max. 700 cm width)	Yes	–
Lowerable Volant-Plus manual or motorised	Yes (up to max. 700 cm width)	Yes	–
Robust Tenara sewing thread as standard	Yes	Yes	Yes
Motor drive	Yes	Yes	Yes
Manual gearbox	Up to 600 cm width and 300 cm projection	Up to 300 cm projection	–
Comfort control (handheld transmitter, weather sensors, smart home)	Yes	Yes	Yes
Wind resistance class	Beaufort 5, 38.5 km/hrr	Beaufort 5, 38.5 km/hrr	Beaufort 5, 38.5 km/hrr
Anti-flap device	Yes	Yes	Yes
Fabric	Acryl & Oeko Weave Soltis Lounge 96, micro-perforated Water Fire Lowerable Volant-Plus: Acryl Soltis Horizon 86 Soltis Harmony 88 Soltis Perform 92 Screens 1% Screens 5% Twilight Water Fire	Acryl & Oeko Weave Soltis Lounge 96, micro-perforated Water Fire Lowerable Volant-Plus: Acryl Soltis Horizon 86 Soltis Harmony 88 Soltis Perform 92 Screens 1% Screens 5% Twilight Water Fire	Acryl & Oeko Weave Water Fire



Selecting the right fabric is crucial when it comes to ensuring high-quality shading. Further information can be found on page 96 or in our digital fabric finder. We'll gladly send a free sample to your home – or advise you on your options.

The possible applications depend on the product configuration. Our consulting team will be happy to assist you in finding the optimal solution.

Product	AZUR SG2400	SELECT S8130/S8135
Open awnings	Yes	Yes
Box awnings	–	–
Award-winning design	–	–
Maximum dimensions Width x projection	700 x 300 cm	1800 x 350 cm
Installation on wall	Yes	Yes
Installation under ceiling	Yes	Yes
Installation on rafters	Yes	Yes
Installation in alcove	–	–
Maximum slope	1°–60° Over 600 cm max. 45°	0°–60°
Manual slope adjustment	–	Yes
Folding arms	Yes	Yes
Telescopic arms	–	–
Semi-cassette (fabric protection)	–	–
Top board	Yes	Yes
Valance	Yes	Yes
Light at front	–	–
Light at rear	–	–
Lowerable Volant-Plus manual	–	Yes
Robust Tenara sewing thread as standard	–	–
Motor drive	Yes	Yes
Manual gearbox	Yes	Yes
Wind resistance class	Beaufort 5, 38.5 km/hrr	Beaufort 5, 38.5 km/hrr
Comfort control (handheld transmitter, weather sensors, smart home)	Yes	Yes
Anti-flap device	Yes	Yes
Fabric	Acryl & Oeko Weave Water Fire	Acryl & Oeko Weave Water Fire Lowerable Volant-Plus: Acryl Soltis Horizon 86 Soltis Harmony 88 Soltis Perform 92 Screens 1% Screens 5% Twilight Water Fire



Selecting the right fabric is crucial when it comes to ensuring high-quality shading. Further information can be found on page 96 or in our digital fabric finder. We'll gladly send a free sample to your home – or advise you on your options.

The possible applications depend on the product configuration. Our consulting team will be happy to assist you in finding the optimal solution.



CAMABOX

The elegant box awning
with a cubic design.

The CAMABOX is more than just an awning – it's an architectural statement. With its cubic design, it blends harmoniously into modern outdoor spaces and impresses with clean aesthetics, especially when closed. Both the fabric and the mechanism are concealed within the cassette, where they are shielded from weather effects and dirt. Integrated LED lighting creates atmospheric moments, while the Lowerable Volant-Plus valance provides extra privacy and glare protection. The CAMABOX is ideal for medium- to large-sized shaded areas and has received a host of prestigious design awards. Perfect for those looking to combine style with functionality.

The CAMABOX impresses with its cubic design and clean lines, lending the facade a modern touch. The fabric, mechanism and folding arms are safely stowed inside the cassette, while the integrated tilting joint ensures precise closing of the box and a tidy appearance. A true design statement for stylish outdoor spaces.



Protected. Neat. Durable.

The fabric and the folding arms inside the cassette are reliably shielded from weather effects such as dirt and UV rays, while the electronics are also tidily integrated: cables and plugs are housed out of sight in the box. A real plus for those who value aesthetics and durable quality.

Raising the bar.

The CAMABOX front bar not only blends in perfectly – it also offers scope for enhancing comfort and convenience. A motorised Lowerable Volant-Plus valance can be integrated as an option – perfect for blocking low sun and enhancing privacy. Tunable White LED lighting can also be incorporated here, allowing infinitely variable dimming and seamless colour adjustment from warm to cool white tones. All of this without any visible additional modules – for a sophisticated design that sets a high bar.



Thanks to its cubic form, CAMABOX tucks neatly into the corner niche when retracted, remaining virtually invisible. When extended, it offers extensive sun protection while accentuating the building's clean lines.

 All the technical details are listed for you on page 50



Light is more than just illumination – it creates atmosphere, accentuates the design and keeps your outdoor space usable even after sunset. The CAMABOX offers integrated lighting solutions that noticeably enhance comfort.



Be it a cosy evening or a lively garden party – the CAMABOX provides light for any occasion. The Tunable White LED technology allows smooth adjustment of the colour temperature – from invigorating cool white to relaxing warm white. This creates an ambience that matches your mood – effortlessly, at the touch of a button.

The separately controllable lighting can be elegantly integrated into the cassette and the front bar, ensuring a clean and tidy look – with no visible mechanisms or additional modules. Light becomes a design feature, enhancing the comfort and atmosphere of your outdoor space, so you can also enjoy your patio in the evening, bathed in atmospheric light.



CAMABOX animation
Be inspired.



PURABOX

Slender. Protected. Minimalist.

The PURABOX is a stylish, functional and pleasantly understated solution designed to create living space. Its 10 cm high cassette makes it the slimmest box awning in the range. Both the fabric and mechanism are safely protected. Its sleek, understated design makes it ideal for small to medium-sized balconies, patios and seated areas. What's more, it's also quick and easy to install. The PURABOX is the perfect awning for those who value functionality, protection and minimalist design.



CASABOX

The compact box awning
for small to medium-sized areas.

For those who value both form and function. Round or square – the CASABOX offers two stylish options to perfectly complement your architecture. The closed cassette reliably shields the fabric from the weather, ensuring lasting quality and minimising maintenance. An optional wall connection profile creates a seamless link to the facade – designed to prevent dirt streaks, protect the building structure and maintain a pristine look. The cassette fully encases the retracted awning – for a tidy look and peace of mind. Ideal for small to medium-sized patio areas, garden patios or balconies.



TENDABOX

Round or square design –
comfort for any architectural style.

The TENDABOX is an elegant box awning for medium- to large-sized patios and garden patios. When the awning is closed, the cassette keeps the fabric and mechanism fully shielded from the elements, preserving its pristine appearance and ensuring long-lasting performance. With a choice of square or round designs, the TENDABOX stylishly adapts to different tastes and architectural styles. The Lowerable Volant-Plus, which can be optionally integrated, offers privacy and additional glare protection when the sun is low – and it can be operated either manually or at the touch of a button, depending on the model.

The TENDABOX is the stylish solution for medium- to large-sized patios and garden patios. Measuring between 1.95 and 6.5 metres in width, with a projection of up to 4 metres, it provides generous shade. The optionally available drop valance offers reliable protection from the low-lying sun while also enhancing privacy.



Round design

The gently rounded awning profile lends the TENDABOX an elegant, soft look – ideal for buildings with curved design language or classic architecture. The closed cassette blends stylishly into the overall setting, protects the fabric from weather effects and keeps everything looking pristine.



Square design

This square awning profile impresses with its precise design language and blends in perfectly with modern facades. The square-design cassette brings structure to the outdoor space and reliably shields the fabric from weather effects. For those who value clean lines and lasting comfort.



Lowerable Volant-Plus – enhanced comfort at the touch of a button

Available as an option for the round design, the drop valance offers reliable protection when the sun is low – ideal in the afternoon or during the transition months. It enhances privacy and, if a transparent fabric is chosen, keeps your view of the outside. It can be controlled either manually or using a convenient handheld transmitter, depending on the model, with the electric version being powered by a solar module.



Whether round or square – the TENDABOX combines stylish design with impressively functional comfort. The optional Lowerable Volant-Plus shields against the low-lying sun and enhances privacy, creating a sheltered outdoor space that flexibly adapts to the sun's position while offering a sense of security.

 All the technical details are listed for you on page 51

Product	CAMABOX BX4000	CAMABOX BX4700
Open awnings	–	–
Box awnings	Yes	Yes
Award-winning design	Yes	Yes
Maximum dimensions Width x projection	600 x 350 cm	700 x 400 cm
Installation on wall	Yes	Yes
Installation under ceiling	Yes	Yes
Installation on rafters	Yes	–
Installation in alcove	–	Yes
Maximum slope	5°–35°	5°–35°
Manual slope adjustment	–	–
Folding arms	Yes	Yes
Telescopic arms	–	–
Semi-cassette (fabric protection)	–	–
Top board	–	–
Valance	–	–
Light at front	–	Yes
Light at rear	Yes	Yes
Lowerable Volant-Plus manual or motorised	–	Yes
Robust Tenara sewing thread as standard	Yes	Yes
Motor drive	Yes / –	Yes / Yes
Manual gearbox	Yes	–
Comfort control (handheld transmitter, weather sensors, smart home)	Yes	Yes
Wind resistance class	Beaufort 4 – 5, 28.4 km/hrr / 38.5 km/hrr	Beaufort 6, 49.5 km/hrr
Anti-flap device	Yes	Yes
Fabric	Acryl & Oeko Weave Soltis Lounge 96, micro-perforated Water Fire Lowerable Volant-Plus: Acryl Soltis Horizon 86 Soltis Harmony 88 Soltis Perform 92 Screens 1% Screens 5% Water Fire	Acryl & Oeko Weave Soltis Lounge 96, micro-perforated Water Fire

 Selecting the right fabric is crucial when it comes to ensuring high-quality shading. Further information can be found on page 96 or in our digital fabric finder. We'll gladly send a free sample to your home – or advise you on your options.

The possible applications depend on the product configuration. Our consulting team will be happy to assist you in finding the optimal solution.

Product	PURABOX BX1500	CASABOX BX2000	TENDABOX BX3000	RESOBOX BX8000
Open awnings	–	–	–	–
Box awnings	Yes	Yes	Yes	Yes
Maximum dimensions Width x projection	500 x 225 cm	550 x 250 cm 500 x 300 cm	650 x 350 cm 600 x 400 cm	1800 x 400 cm
Installation on wall	Yes	Yes	Yes	Yes
Installation under ceiling	Yes	Yes	Yes	Yes
Installation on rafters	Yes	Yes	Yes	Yes
Installation in alcove	Yes	Yes	Yes	–
Maximum slope	–	–	–	–
Manual slope adjustment	0°–90°	5°–90°	5°–85°	0°–40°
Folding arms	Yes	Yes	Yes	Yes
Telescopic arms	–	–	–	–
Semi-cassette (fabric protection)	–	–	–	–
Top board	–	–	–	–
Valance	–	–	–	–
Light at front	–	–	–	–
Light at rear	–	–	–	–
Lowerable Volant-Plus manual or motorised	–	–	–	–
Robust Tenara sewing thread as standard	–	–	–	Yes (up to max. 1400 cm width)
Motor drive	–	–	–	–
Manual gearbox	Yes / Yes	Yes / Yes	Yes / Yes	Yes
Comfort control (handheld transmitter, weather sensors, smart home)	Yes	Yes	Yes	–
Wind resistance class	Beaufort 5, 38.5 km/hr	Beaufort 5, 38.5 km/hr	Beaufort 5, 38.5 km/hr	Beaufort 5, 38.5 km/hr
Anti-flap device	Yes	Yes	Yes	Yes
Fabric	Acryl Oeko Weave Fire	Acryl & Oeko Weave Soltis Lounge 96, micro-perforated Water Fire	Acryl & Oeko Weave Soltis Lounge 96, micro-perforated Water Fire	Acryl & Oeko Weave Water Fire Lowerable Volant-Plus: Acryl Soltis Horizon 86 Soltis Harmony 88 Soltis Perform 92 Screens 1% Screens 5% Twilight Water Fire

 Selecting the right fabric is crucial when it comes to ensuring high-quality shading. Further information can be found on page 96 or in our digital fabric finder. We'll gladly send a free sample to your home – or advise you on your options.

The possible applications depend on the product configuration. Our consulting team will be happy to assist you in finding the optimal solution.



PERGOLINO

The perfect fit.

PERGOLINO transforms your patio into a favourite spot no matter what the weather – in the sun, wind or even rain. The facade-mounted pergola awning offers reliable protection and provides a sense of security. The individually repositionable supports ensure maximum flexibility and stability – even in changeable weather. Stays looking good, stays taut – the automatic fabric tensioning prevents water pockets, so the fabric keeps its shape even in the rain. Dimmable lighting lets you create just the right atmosphere for any moment in the evening.



Flexible installation. Just how you like it.

Thanks to its versatile mounting options, PERGOLINO can be attached both to the wall and to the ceiling – using specially developed ceiling brackets for a secure and stable installation. Special highlights include the repositionable supports, plus guide rails with adjustable width and depth. Even the fixing brackets can be flexibly positioned – for maximum design freedom and optimum integration into your surroundings.

For ground fastening, there is a choice of planter, ground sleeve or base plate – depending on the situation and your preferred style. Each model guarantees optimum stability. Even when the wind picks up, you can rely on PERGOLINO standing firm thanks to its high wind stability – for carefree hours in the open air.

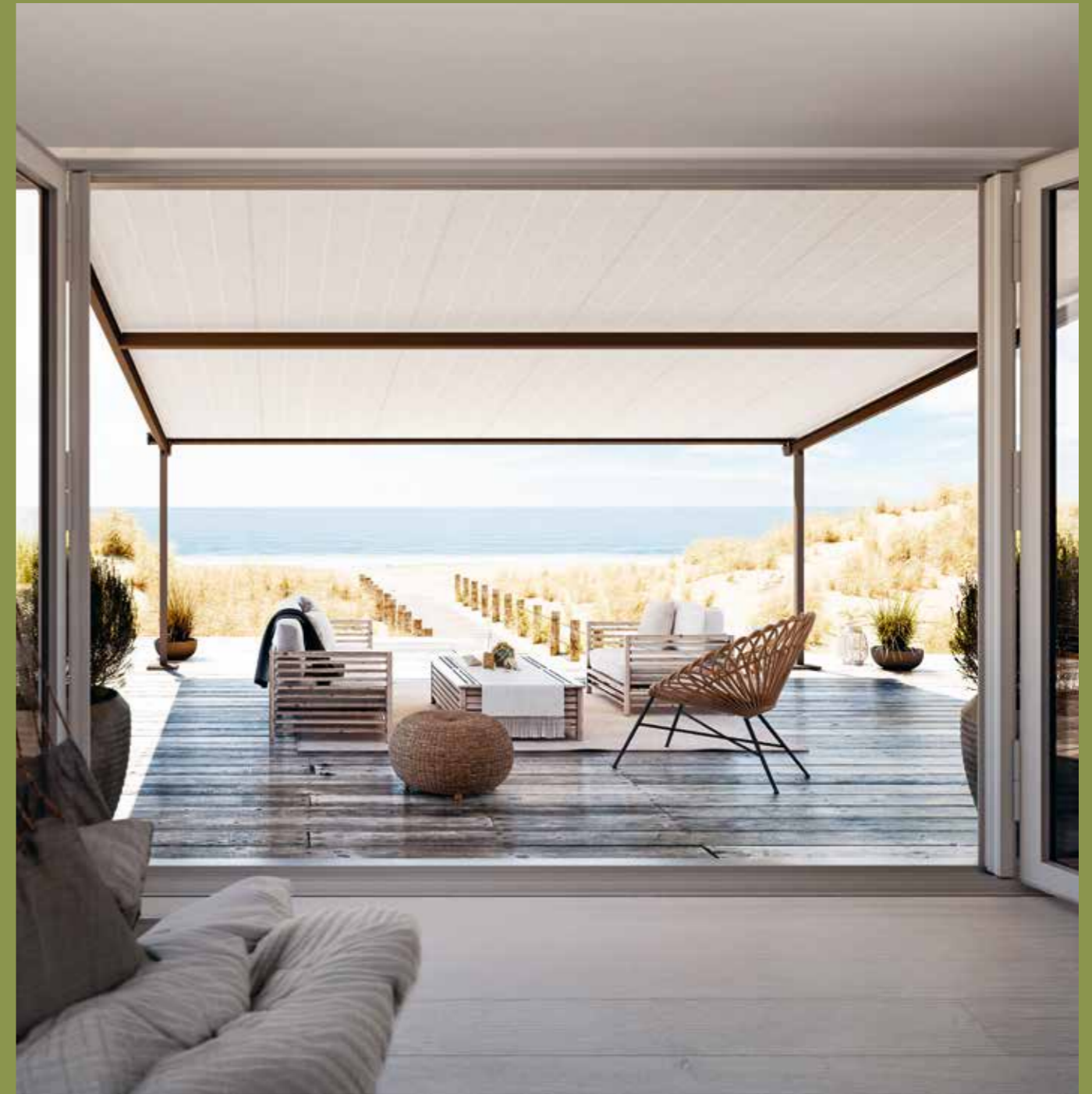

All the technical details are listed for you on page 71

STOBLOCK takes care of the adjustments – leaving you to relax



In addition to being a real eye-catcher, the PERGOLINO pergola awning makes your outdoor space even more inviting. The STOBLOCK system automatically keeps the fabric taut, with no need for manual readjustment – come rain, shine or wind. For you, this means no creases, no water pockets and no worries. Choosing the right slo-

pe and fabric keeps the rainwater drainage under control, while the fabric stays flawlessly smooth day after day. STOBLOCK ensures comfort and safety – without you having to do anything, leaving you to relax and enjoy your time outdoors, safe in the knowledge that you are well protected.



Scan the QR code and watch the STOBLOCK video.

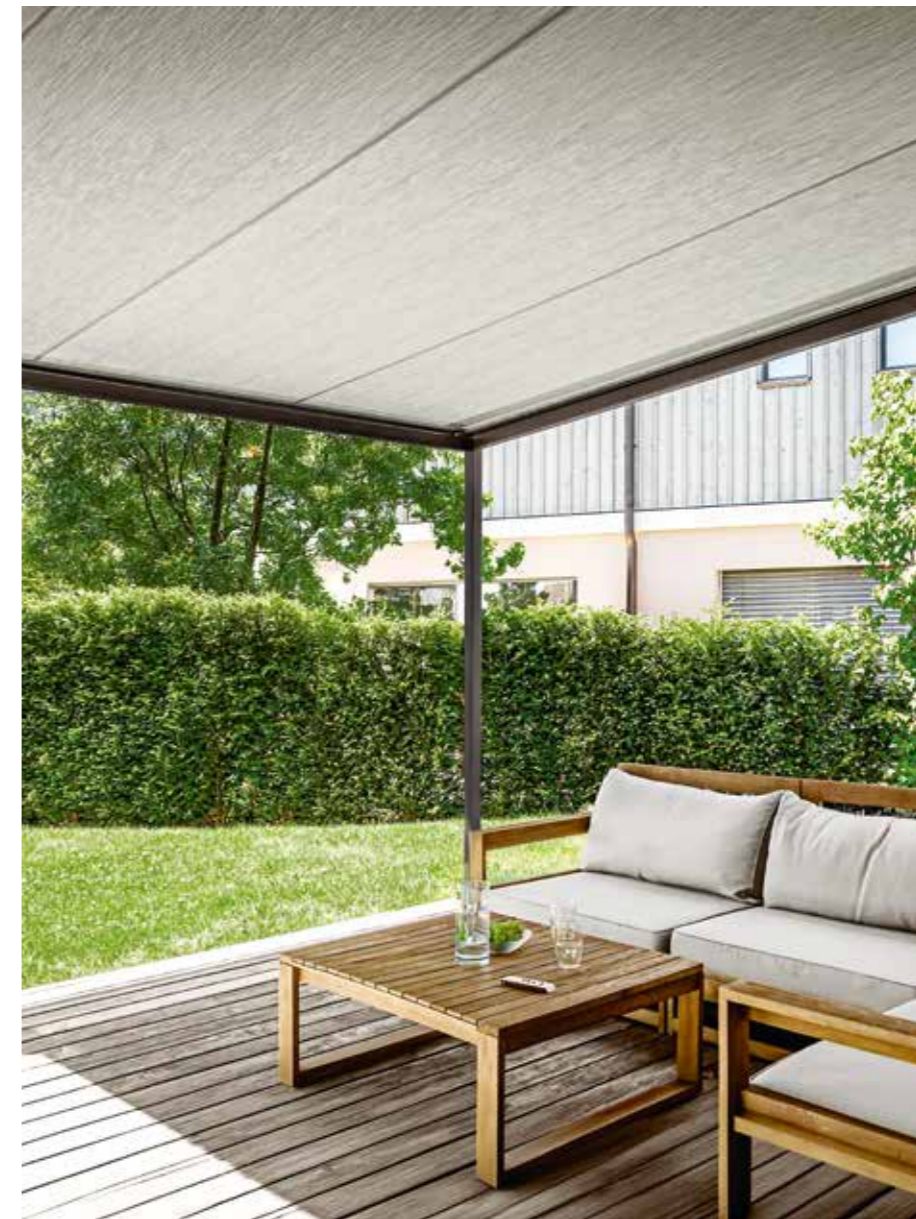

**Atmospheric light**

Enjoy your patio in the evening, too – thanks to the integrated LED lighting. You decide whether to integrate the lighting into the guide tube, the guides or both. Whether soft, warm light for relaxing or bright, clear light for reading or eating – Tunable White technology makes it easy to adapt the lighting to your mood. As well as being practical, the lighting is also discreetly integrated into the product design, creating a pleasant atmosphere that fills your outdoor area with a sense of well-being.



BOXMOBIL

Two cassettes. One inspiring system.

Generous shade. Whether on the penthouse terrace, in the garden or on the patio – BOXMOBIL provides reliable sun protection in medium to large areas. Two box awnings are mounted on a stable steel support structure – with no obstructive centre support, leaving the space beneath fully usable. There are two designs available: one with a square front rail, one with a round front rail. The freestanding double awning is easy to operate using a crank handle, making it ideal for flexible usage. For even greater convenience, there is an optional motorised drive available, which extends the two awnings either simultaneously or separately at the push of a button. BOXMOBIL really comes into its own on rooftop terraces with limited structural options or when planning is done retrospectively.



A choice of supports with one thing in common – stability

The Boxmobil stands firm, no matter how you choose to install it. The robust supports can be either discreetly anchored in the ground using recessed ground sleeves or fitted with concrete bases. Both versions remain stable in wind or bad weather while blending in seamlessly with their surroundings – for a great outdoor feeling whatever the weather.



Drop valance – more than just shade

As the sun dips low and bathes the day in golden light, the drop valance turns every outdoor moment into pure relaxation. The drop-down valance with glare protection, easily lowerable using the crank handle, provides reliable protection from sunlight. Thanks to the floating system, the fabric rolls up exceptionally evenly. Choose either opaque acrylic fabric up to 110 cm or translucent fabric up to 160 cm – for more privacy and a feeling of freedom.





OMBRAMOBIL

The mobile place in the shade.

Make the most of summer in the perfect spot – with the STOBAG OMBRAMOBIL. This freestanding double awning can be flexibly positioned and usually requires no planning permission thanks to its mobile design. Ideal for small to medium-sized seated areas, it provides reliable protection from the sun where you need it most. It has a crank handle for convenient manual operation, and both shades extend simultaneously. Your own personal open-air haven.



Securely fastened – however you like.

There are various options for securing the double awning: the supports can be anchored either in the ground using ground sleeves or on stable surfaces using T-feet. Another option instead of a support is one-sided wall mounting – for greater design freedom during planning.



Freedom beneath the awning

OMBRAMOBIL provides shade as well as ensuring comfort. The fabric remains well protected in any weather thanks to the integrated top board. In addition, the construction requires no obstructive centre supports, leaving the space beneath the awning fully usable. One particularly practical feature is the small gutter on the front bar, which reliably drains away light summer rain, leaving your seated area pleasantly sheltered even in brief showers.





SIRO FLEX

Privacy and wind protection in one move.

SIRO FLEX is the practical side awning for your seated area, as it protects you from the sun and wind while also giving you more privacy. Stowed in a compact aluminium cassette, SIRO FLEX can be extended and securely attached in one move. It can be mounted using either a wall bracket, a ground sleeve or a support. Select from a wide range of fabric colours and choose transparent or opaque fabric. SIRO FLEX blends discreetly into the ambience and offers reliable protection whenever you need it.



Product	PERGOLINO P3600	BOXMOBIL OS7000	OMBRAMOBIL OS4000	SIRO FLEX
Maximum dimensions Width x projection	700 x 600 cm With 3 guide rails for widths of 601 cm or more	662 x 700 cm	555 x 450 cm	200 x 400 cm
Maximum installation height	250 cm	303 cm	260 cm	–
Slope	0° – 25° Use in rain at least 8°	5° – 35°	10° – 20°	–
Installation on wall	Yes	One-sided	One-sided	Yes
Installation under ceiling	–	–	–	–
In-reveal installation	–	–	–	–
Freestanding installation	–	Yes	Yes	–
Installation on existing substructure	Yes	–	–	–
Folding awning as roof shading	–	–	–	–
Side/front shades	–	Drop valance	Valance	Yes
Side/front glazing	–	–	–	–
Linking of installations	–	Yes	–	–
Integrated water drainage system	–	–	–	–
Lighting	Yes	–	–	–
Motor drive	Yes / –	Yes / Yes, up to a maxi- mum width of 612 cm drop valance only with the gearbox	Yes / Yes	–
Wind resistance class	Beaufort 6 49.5 km/hr	Beaufort 5 38.5 km/hr	Beaufort 5 38.5 km/hr	Beaufort 6 49.5 km/hr
Fabric	Acryl Water Fire	Acryl & Oeko Weave Water Fire Lowerable Volant-Plus: Acryl Soltis Horizon 86 Soltis Harmony 88 Soltis Perform 92 Screens 1% Screens 5% Twilight Water Fire	Acryl & Oeko Weave Water Fire	Acryl & Oeko Weave Soltis Horizon 86 Soltis Harmony 88 Soltis Perform 92 Screens 1% Screens 5% Water Fire



Selecting the right fabric is crucial when it comes to ensuring high-quality shading. Further information can be found on page 96 or in our digital fabric finder. We'll gladly send a free sample to your home – or advise you on your options.



ARNEX

Big impact, small footprint.

The ARNEX conservatory shading line from STOBAG combines clean aesthetics, technical refinement and convenient operation in a single product line. Whether as underglass shading for discreet integration or as an overglass awning for maximum protection from the heat – both variants offer ingenious solutions for your expanded, protected living space. The ZIP fabric guide keeps the fabric constantly taut and prevents light gaps – even in windy conditions – ensuring a sleek, harmonious look combined with dependable sun and glare protection.

The sleek, compact design, which blends harmoniously into the building, has received multiple design awards, highlighting its aesthetic and technical excellence as well as the high standards of quality and style. Thanks to the motor drive, fitted as standard, shading can be controlled conveniently at the touch of a button – or optionally via a smart-home system. For even greater comfort and convenience, the awning can be connected to a weather protection system that automatically responds to sun, wind or rain.

ARNEX conservatory shading regulates the temperature either below or above the glass roof, transforming your conservatory into an oasis of well-being – all year round.



Shading – overglass or underglass

The ARNEX PS8000 roof shading elegantly integrated above the glass provides reliable protection from intense sunlight and heat. The fabric shading on the outside naturally regulates both light and heat, creating a noticeably comfortable indoor climate. The sun is blocked before it hits the glass – keeping heat out and your space beneath the roof comfortably cool. For enhanced comfort, well-being and relaxation with an open-air feeling.



The ARNEX PS2500 model is installed as roof shading below the glass – a solution that impresses with its aesthetic appeal while remaining protected under the roof.

Individual. Comfortable. Stylish.

Whether underglass or overglass – each solution is as unique as your home. Thanks to a wide range of frame and fabric colours, the shading can be discreetly integrated into the structure or employed as a design feature. Motorised operation ensures maximum convenience: the shading can be controlled effortlessly at the touch of a button – or automatically via an integrated weather protection system. The awning extends automatically when the sun is shining brightly and the temperature starts to rise – so your conservatory is already pleasantly cool when you arrive home, leaving you to relax and enjoy your coffee rather than have to worry about setting the controls.

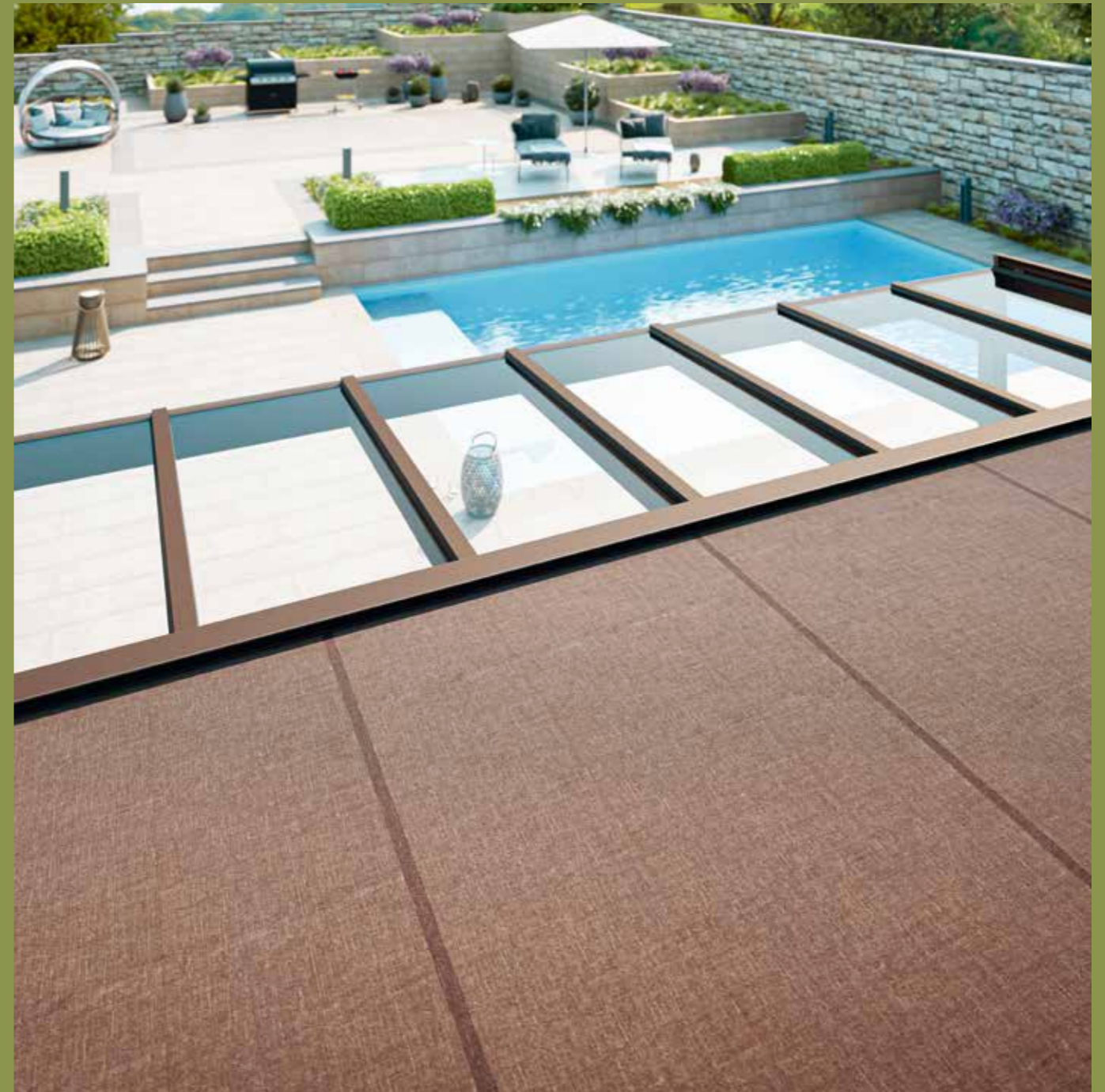

 All the technical details are listed for you on page 85



TARGA

Out of the ordinary.

Two models offer optimum adaptability and harmonious integration – for classic or more unusual roof shapes. TARGA and TARGA Plus provide welcome sun protection for large and complex glass surfaces. The guide rails are highly practical as they can be moved inwards, making an ideal solution possible – even for non-standard shapes. The patented projection mechanism extends the shaded area beyond the glass surface, providing extra coverage. Cutting-edge technology keeps the fabric perfectly taut, creating a sleek, harmonious look – even on installations up to 7 metres wide.

The self-supporting structure with adjustable guide rails and Plus projection provides sun protection over a wide area – even when the sun is low.



**Engineered for strength –
designed for flexibility**

The TARGA boasts an impressive self-supporting structure; the sleek box provides sturdy support without the need for mounting on the facade, with a clean side finish and a cleverly concealed electric plug. Enjoy extensive sun protection with uninterrupted shading over a width of up to 7 metres.



As flexible as your conservatory

The guide rails can be adjusted inward continuously by up to 100 cm, offering maximum flexibility for bespoke conservatory designs and individual requirements. The patented Plus projection extends the sun protection beyond the front of the conservatory, creating up to 140 cm more shade – so your conservatory remains comfortable and glare-free, even when the sun is low.





AIROMATIC

Compact, slender and reliable.

The AIROMATIC line features two models that are ideal for both small and medium-sized conservatories up to 33 m²; it is therefore suitable for most conservatory designs and offers the right sun protection for almost any situation. The slim structure blends in harmoniously with the overall appearance of your home and impresses with its discreet look, simple installation, and reliable protection from heat and intense sunlight. For relaxing hours in your conservatory at home – any way you like.

Be it a conservatory or a large skylight, having sun protection on the outside creates a comfortable indoor climate and welcoming light. Your favourite spot remains cool and glare-free, even on hot days.



Perfect for small and large areas

The exceptionally compact PS4000 model is suitable for smaller areas up to 16 m², while the larger PS4500 box model is ideal for shading conservatories up to 33 m². The self-supporting structure ensures stability and a slimline look – and it fits seamlessly into even the smallest of areas. Integrated gas struts guarantee uniform fabric tension for perfect sun protection. The guide rail allows seamless installation, while a range of brackets ensures maximum flexibility – for a design that is both functional and sleek. A built-in motor makes for convenient operation – at the touch of a button.

Inspiring colours. Noticeable comfort.

Choose from a wide range of high-quality fabric colours and textiles offering high UV protection as well as outstanding resistance to fading and sunlight. And enjoy first-class sun protection while giving your outdoor space your own personal touch.



 All the technical details are listed for you on page 85



Product	ARNEX PS8000	ARNEX PS2500	TARGA PS6000	TARGA PS6100 Plus	AIROMATIC PS4000	AIROMATIC PS4500
Maximum dimensions Width x projection	600 x 600 cm	600 x 450 cm	700 x 700 cm	700 x 700 cm Plus projection: 60 cm, 100 cm or 140 cm	400 x 400 cm	550 x 600 cm
Slope	3° – 60°	0° – 25°	3° – 35°	3° – 35°	3° – 90°	3° – 90°
In-reveal installation	Yes	–	–	–	–	–
Installation on existing substructure	Yes	Yes	Yes	Yes	Yes	Yes
Drive system Motor drive/ gearbox	Yes / –	Yes / –	Yes / –	Yes / –	Yes / –	Yes / –
Variable guide positions	–	–	Yes	Yes	–	–
ZIP system	Yes	Yes	–	–	–	–
Wind resistance class	Beaufort 6 49.5 km/hrr	Beaufort 6 49.5 km/hrr	Beaufort 6 49.5 km/hrr	Beaufort 6 49.5 km/hrr	Beaufort 6 49.5 km/hrr	Beaufort 6 49.5 km/hrr
Fabric	Acryl	Acryl	Acryl Water Fire	Acryl Water Fire	Acryl Water Fire	Acryl Water Fire



Selecting the right fabric is crucial when it comes to ensuring high-quality shading. Further information can be found on page 96 or in our digital fabric finder. We'll gladly send a free sample to your home – or advise you on your options.



Hospitality and commercial

STOBAG awnings for inviting terraces.

Whether for a hotel terrace, restaurant or café - a high-quality awning solution from STOBAG lets you create pleasant shade at the push of a button, inviting guests to relax and turning your outdoor space into their favourite place.

Our JUMBO, RESOBOX, PERGOLINO and VIVO models offer generous dimensions, sophisticated technology and maximum flexibility. At the same time, STOBAG has the ideal solution for any terrace size – optionally with comfort features such as dimmable LED lighting – to create an atmosphere that will delight guests, even during the evening hours.



JUMBO is an open large-area awning for anyone who thinks about shade on a new scale. With a maximum projection of up to 5 metres and a width of up to 18 metres, it covers an impressive 90 m² – ideal for expansive terraces. Up to six powerful telescopic arms ensure consistently high fabric tension and give the awning its distinctive form. The robust

aluminum construction provides exceptional stability. An optional protective roof is available to shield the awning fabric from dirt and weather when retracted. An optional valance, available in various shapes, conceals the awning arms when closed and creates a harmonious overall appearance.



Large, wide and generous projection: RESOBOX is the ideal solution for reliable shade for particularly large terraces and outdoor areas. With a single system, it covers an impressive 70 m² – whether in a private garden, on a café's sun terrace, or in a restaurant's outdoor area. The patented cassette system reliably protects the fabric and articulated arms from wind and weather, ensuring a long service life and a well-maintained appearance. Optionally, the lowerable Drop Valance provides additional privacy and glare protection when the sun is low in the sky.





Landscape architecture Studio Leaf AG, www.studioleaf.ch
 Photographer Quim Vilar, www.quimvilar.com



The PERGOLINO pergola awning offers high wind stability and reliable fabric tension for the hospitality sector. See more product details on page 53.



Product	JUMBO S2160/2	RESOBOX BX8000	VIVO S6800
Open awnings	Yes	-	Yes
Box awnings	-	Yes	-
Award-winning design	-	-	Yes
Maximum dimensions Width x projection	1800 x 500 cm	1800 x 400 cm	1800 x 400 cm
Installation on wall	Yes	Yes	Yes
Installation under ceiling	Yes	Yes	Yes
Installation on rafters	-	-	Yes
Installation in alcove	-	-	-
Maximum slope	5° – 22°	0° – 40°	0° – 60°
Manual slope adjustment	-	-	-
Folding arms	Yes	Yes	Yes
Telescopic arms	Yes	-	Yes
Semi-cassette (fabric protection)	-	-	Yes (up to max. 600 cm width)
Top board	Yes	-	Yes
Valance	Yes	-	Yes
Light at front	-	-	Yes (up to max. 700 cm width)
Light at rear	-	-	Yes (up to max. 700 cm width)
Lowerable Volant-Plus manual or motorised	-	Yes (up to max. 1400 cm width)	Yes (up to max. 700 cm width)
Robust Tenara sewing thread as standard	Yes	Yes (up to max. 1400 cm width)	Yes
Motor drive	Yes	Yes	Yes
Manual gearbox	-	-	Up to 600 cm width and 300 cm projection
Comfort control (handheld transmitter, weather sensors, smart home)	Yes	Yes	Yes
Wind resistance class	Beaufort 5, 38.5 km/hr	Beaufort 5, 38.5 km/hr	Beaufort 5, 38.5 km/hr
Anti-flap device	Yes	Yes	Yes
Fabric	Acryl & Oeko Weave Water Fire	Acryl & Oeko Weave Water Fire Lowerable Volant-Plus: Acryl Soltis Horizon 86 Soltis Harmony 88 Soltis Perform 92 Screens 1% Screens 5% Twilight Water Fire	Acryl & Oeko Weave Soltis Lounge 96, micro-perforated Water Fire Lowerable Volant-Plus: Acryl Soltis Horizon 86 Soltis Harmony 88 Soltis Perform 92 Screens 1% Screens 5% Twilight Water Fire



Selecting the right fabric is crucial when it comes to ensuring high-quality shading. Further information can be found on page 96 or in our digital fabric finder. We'll gladly send a free sample to your home – or advise you on your options.

The possible applications depend on the product configuration. Our consulting team will be happy to assist you in finding the optimal solution.

Fabric

Selecting the right fabric is crucial when it comes to ensuring high-quality shading. Colours, textures and material properties all have a bearing on aesthetics, comfort and functionality. All our fabrics provide high UV and heat protection. They can also be translucent, water-resistant, fire-resistant or darkened, depending on the material and coating – so there's an ideal solution to meet any need and any design requirements.

Light and heat protection

Targeted regulation of daylight, heat and transparency for windows with ZIP vertical awnings.

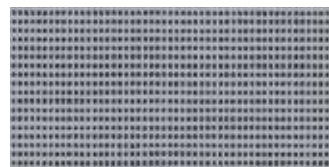

Soltis Horizon 86

Unobstructed views of the outside thanks to maximum transparency. With an opening factor of 14%, the fabric lets in natural light while blocking up to 93% of the heat.



Soltis Harmony 88

Fabric transparency allows a view of the outside. With an opening factor of 8%, the fabric strikes the perfect balance between keeping the sun out and letting the world in.



Soltis Perform 92

Thanks to its low opening factor of 4%, the fabric blocks out lots of light and almost all the heat. Blocks up to 97% of the heat and provides outstanding sun and glare protection.



Soltis Veozip

Optimised for window and facade awnings with ZIP guide. Featuring an attractive matt surface and a textile look and feel. With an opening factor of 5%, it strikes a perfect balance between sun protection and pleasant transparency.

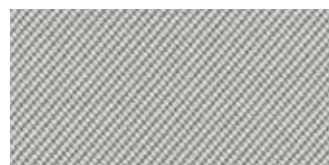

Screens 1%

Stable and durable thanks to coated fibreglass yarns – with an attractive woven texture and two-tone look. The 1% fabric opening factor blocks heat, lets in light and ensures a view of the outside while also providing privacy.



Screens 5%

Coated fibreglass yarns for lasting strength and fabric stability. With attractive woven texture and two-tone look. The opening factor of 5% ensures transparency.



Twilight

100% PVC-free fabric with textile character. The mesh fabric is durable and translucent, with an opening factor of 1.9%.

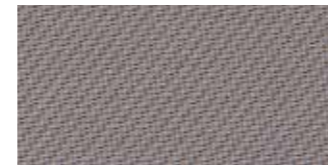

Blockout

The blockout fabric ensures complete darkening and maximum privacy – ideal for spaces that require protection from light and prying eyes.

Sun protection and weather resistance

Effective protection from the sun and weather for awnings and vertical awnings on balconies and patios.



Acrylic

Offers outstanding protection from UV radiation. High-quality acrylic fabrics retain their colour for a long time. Available in solid colours, or with narrow, wide or multi-coloured stripes, or in “Brilliant” design – the exclusive premium version.



Oeko-Weave

Gives over 30% RE-USE fibres a second chance and is certified to Class 2 of the OEKO-TEX standard 100 and OEKO-TEX MADE IN GREEN for effective sustainability.

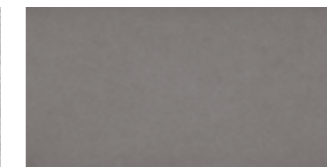

Water

Special waterproof acrylic fabric as an all-weather solution. A water- and stain-resistant outer coating protects the fabric.



Fire

Flame-retardant design with a water-repellent coating for weather resistance.



Resistant

Suitable for outdoor use all year round and 100% waterproof. This fabric is used for the STOBAG BAVONA Soft-Top and RIVERA products.



Soltis Lounge 96

More light and more air circulation thanks to microperforated material, plus 97% blockage of UV rays. The glare-free view of the outside gives an even greater feeling of freedom. High UV stability for enduringly beautiful colours.



Explore our wide range of fabrics using the online fabric finder and order samples.

Our fabrics offer a wide range of functions – from shade and variable translucence to water and fire resistance and complete darkening. Many of the fabrics are ideal for specific STOBAG products. Here is an overview of combinations that work particularly well.

	Shade	Transparency	Fire resistance	Water resistance	Darkening	Vertical awnings	Articulated-arm and telescopic-arm awnings	Patio roofs
SOLTIS HORIZON 86		✓	✓			YES	YES*	YES*
SOLTIS HARMONY 88		✓	✓			YES	YES*	YES*
SOLTIS PERFORM 92		✓	✓			YES	YES*	YES*
SOLTIS VEOZIP		✓	✓			YES	YES*	YES*
SCREENS 1%		✓	✓			YES	–	YES*
SCREENS 5%		✓	✓			YES	–	YES*
TWILIGHT		✓	✓			YES	–	YES*
BLOCKOUT	✓		✓		✓	YES	–	YES*
ACRYL	✓					YES*	YES	YES*
OEKO-WEAVE	✓					YES*	YES	YES*
WATER	✓			✓		YES*	YES	YES*
FIRE	✓		✓			YES*	YES	YES*
RESISTANT	✓		✓	✓	✓	–	–	YES*
SOLTIS LOUNGE 96	✓	✓	✓			–	YES	–





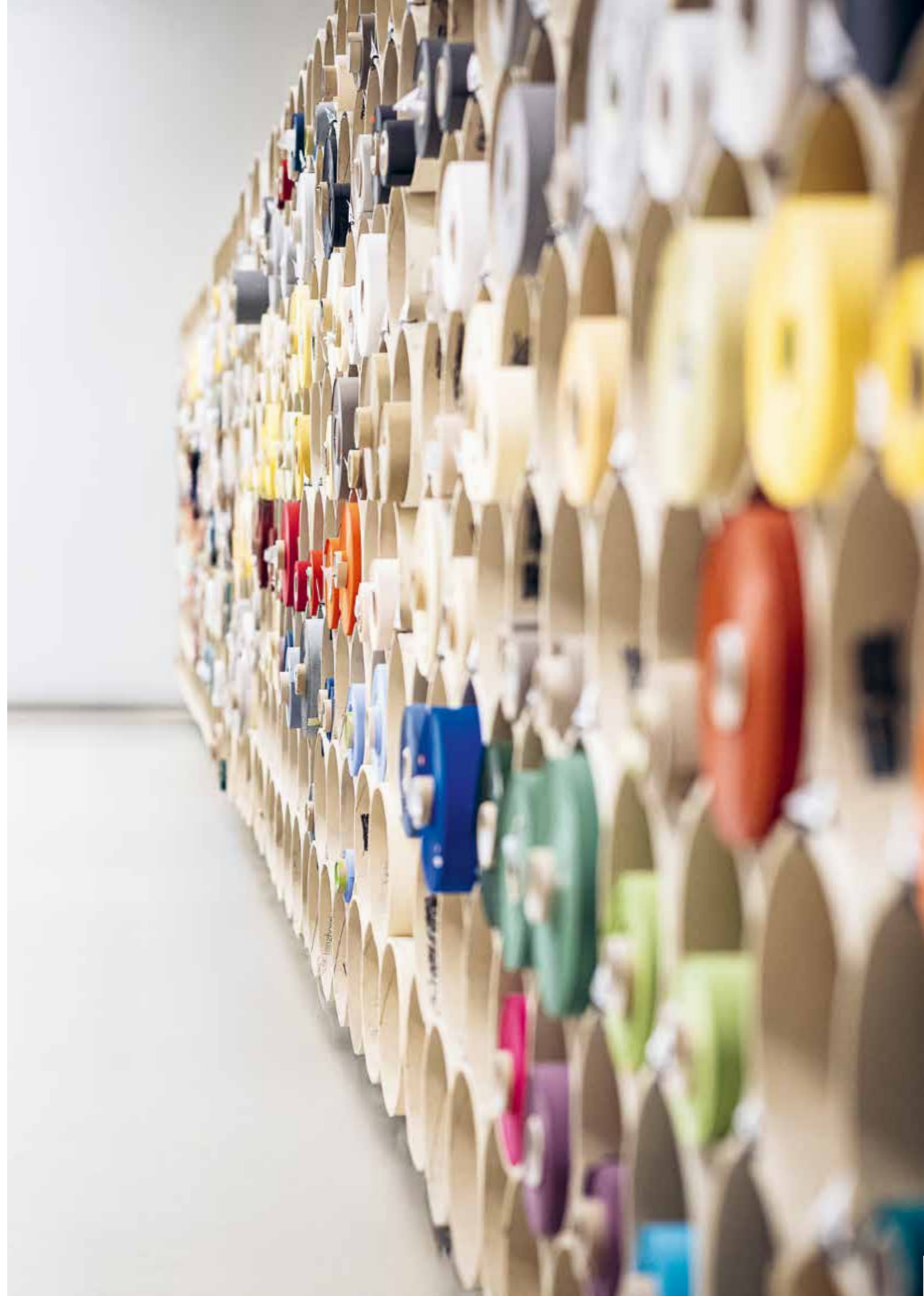







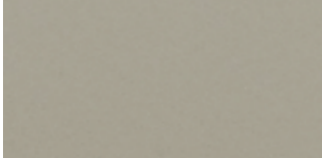

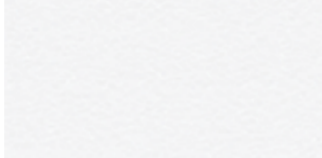

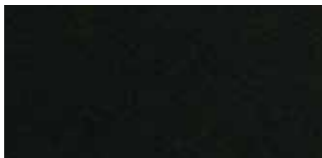
* The application options depend on the product configuration. Get advice from us or your STOBAG dealer.

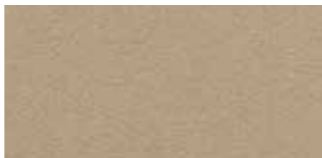

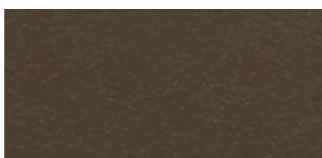
Frame

Thanks to a wide choice of colours and surfaces, the frames blend in perfectly with the overall design – matched to the fabric and the surroundings. With 16 LIFESTYLE colours, 8 CLASSIC colours and a multitude of RAINBOW colours, the wide range has the ideal solution to suit any taste. Our surface structure varies depending on the colour shade – from shiny to matte to finely structured surfaces. All profiles and components have a high-quality powder coating and offer durable weather protection.

LIFESTYLE colours

			
L12 – Classic 31 SILK GREY	L22 – Classic 37 UMBRA GREY	L40 – RAL 9016 TRAFFIC WHITE	L42 – RAL 9006 WHITE ALUMINIUM
			
L24 – RAL 9005 JET BLACK	L20 – Classic 35 BLACK BROWN	L48 – RAL 7016 ANTHRACITE GREY	L56 DESERT ORE
			
L18 – Classic 34 MOCHA BROWN	L30 – Style 30 MEDIUM BRONZE	L52 BROWN GREY	L70 TEXTURED BRONZE
			
L14 – Classic 32 CONSTRUCTION SILVER	L28 – RAL 8004 COPPER BROWN	L58 CUPRUM SPIN	L54 GOLD SAND

CLASSIC colours

	
C10 – RAL 9016 TRAFFIC WHITE	C12 – RAL 9010 PURE WHITE
	
C28 – RAL 9006 WHITE ALUMINIUM	C30 – RAL 9007 GREY ALUMINIUM
	
C34 – DB703 FERRITE	C48 – RAL 7022 UMBRA GREY
	
C50 – RAL 7016 ANTHRACITE GREY	C52 – RAL 9005 JET BLACK

RAINBOW colours

With the RAINBOW colours, we offer a wide range of standard RAL options. These colours captivate with a smooth, satin-like sheen free of effects.

They allow harmonious matching of the frame colours with the fabric design and the surroundings. If you still can't find what you're looking for, please get in touch – we'll find a solution for you.



Comfort at the push of a button

It's this easy to control your home.

More freedom, more quality of life – electric control lets you enjoy even more comfort and convenience in your home. STOBAG offers high-quality solutions – from practical handheld transmitters to seamless integration into popular smart-home systems – for sun, light and weather protection that adapts to your daily needs and the weather. You can control everything conveniently using a handheld transmitter or an app on your smartphone.

Choose between classic control and smart solutions that adapt to your daily needs and the weather.



Handheld transmitter

Simple, clear and convenient. Thanks to up to 16 channels, you can control several functions or products using a single transmitter – to meet all your needs.

Sensors

Sensors detect wind, sun and rain, and control your system automatically. This keeps your sun protection safe, leaving you to enjoy a carefree day. In strong winds, the awnings retract in plenty of time to protect the installation. In intense sunlight, they activate the sun protection, preventing your home from overheating.

Smart Home

STOBAG gets you ready for a smart home. You can control everything centrally using the TaHoma app – conveniently on your smartphone or tablet or by voice command, whether you're relaxing at home on the couch or out and about. This lets you keep an eye on all the functions and save custom scenarios such as «evening light» or «sun protection active». Your system reacts automatically to changes in the weather, enhances comfort and convenience, and prolongs the life of your products. At the same time, energy efficiency increases: the sun protection closes in summer to keep heat out, while the sun's warmth is used in winter to create a pleasant indoor climate. For complex living concepts, there are also interfaces to wired control systems such as KNX and DALI.

Retrofittable as and when you need

Needs change – and our products change with them. Almost all of our installations can be subsequently expanded or modernised. You can simply switch your existing solution from cable to radio control, integrate it into a smart home or add sensors. It's also possible to incorporate additional products at any time. Your home therefore remains flexible and adapts to your needs – now and in the future.

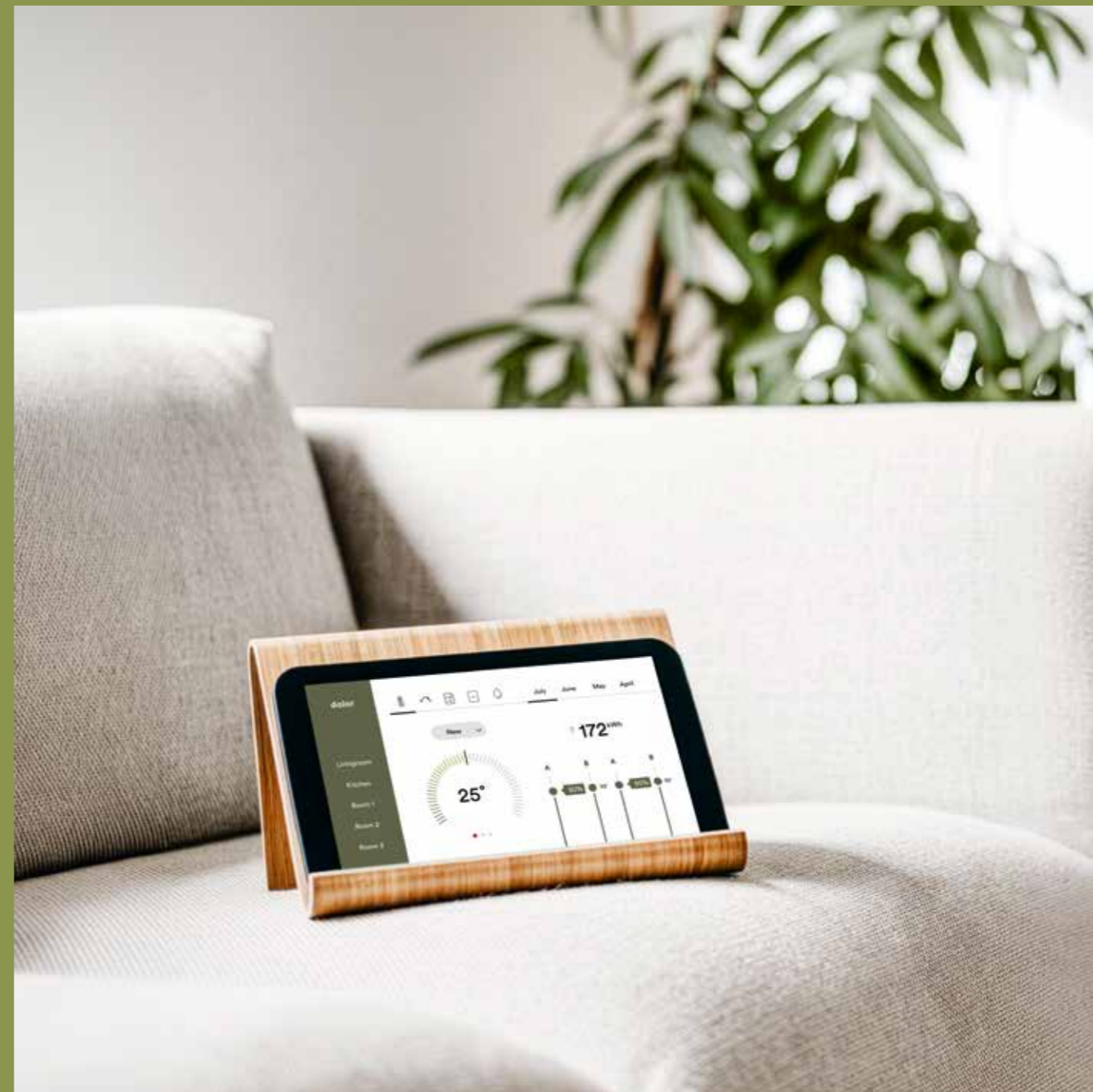

Whether for awnings, patio roofs or vertical shading – everything can be operated and controlled centrally. Open and close awnings with a single click, adjust or dim the light how you like, or change the colour temperature. Even the drop valance can be extended and retracted with ease, the slats on slat roofs rotate into any desired position, and side shades react flexibly to your needs. Choose between classic control and smart solutions that adapt to your daily needs and the weather.

Bespoke advice for your project

Experience the variety of our sun and weather protection solutions live – in one of our STOBAG showrooms. Our experts provide comprehensive advice on patio roofs, shading solutions, and the right fabric selection.



Book an appointment at one of our showrooms:
www.stobag.com/goto/showroom

Would you like a consultation at your home? Our experienced specialists will advise you personally and take care of planning and installation.



Find a specialist near you:
www.stobag.com/goto/dealer-search

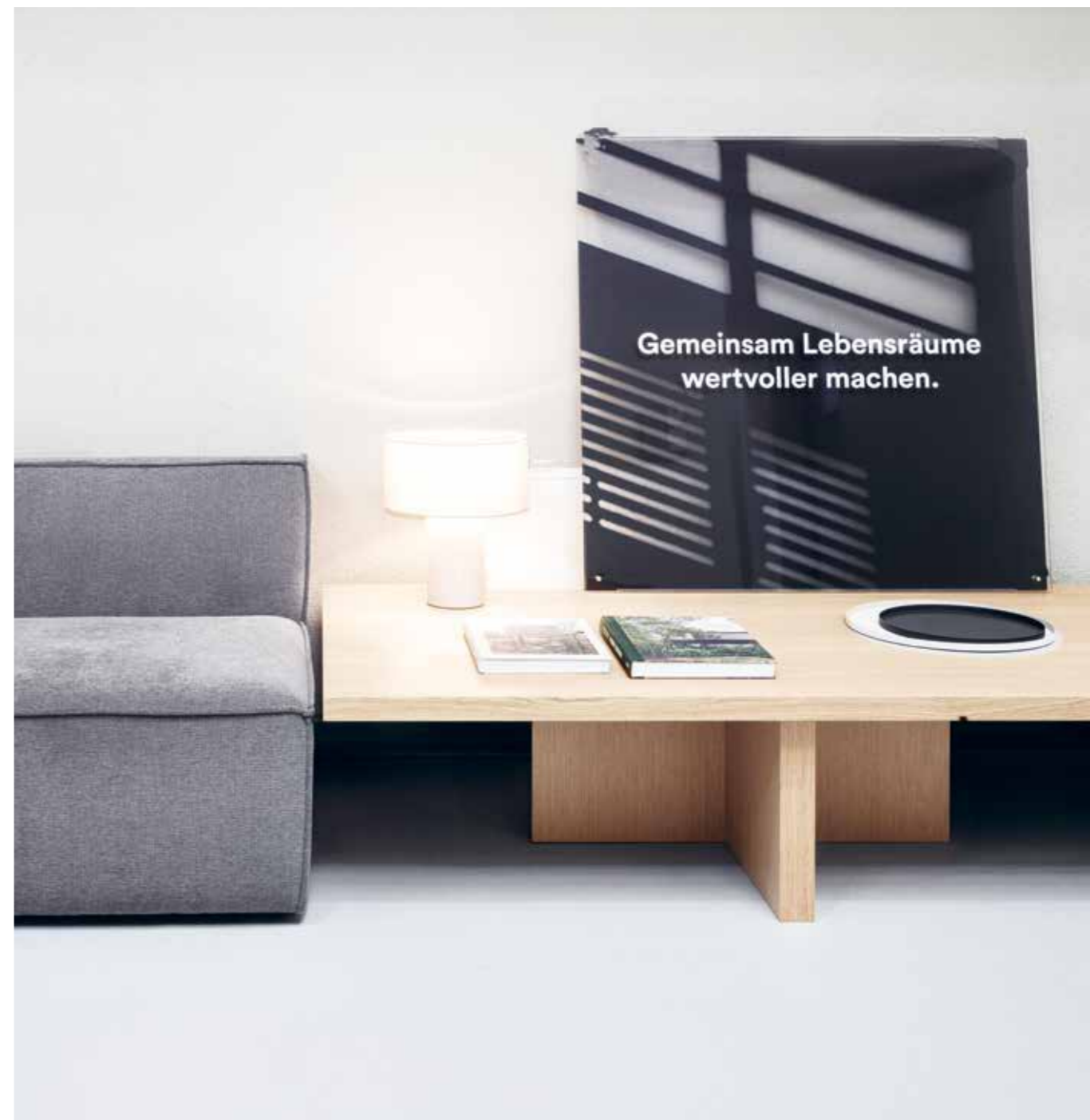

STOBAG AG
 German-speaking
 Switzerland / Ticino
 Pilatusring 1
 5630 Muri
 Switzerland

STOBAG SA
 French-speaking
 Switzerland
 En Budron H / 18
 1052 Le Mont-sur-Lausanne
 Switzerland

STOBAG
 Österreich GmbH
 Radlberger Hauptstrasse 100
 3105 St. Pölten-Unterradlberg
 Austria

STOBAG AG
 Europe
 Pilatusring 1
 5630 Muri
 Switzerland

STOBAG
 North America Corp.
 1445 Norjohn Ct Unit 7
 Burlington, ON L7L OE6
 Canada

Key

SURFACE SHINE

DEEP MATT	
MATT	
HIGH-GLOSS / SATIN	

SURFACE STRUCTURE

SMOOTH	
FINE STRUCTURE	





SURFACE EFFECT

HOMOGENEOUS	
PERGLIMMER	





PROPERTIES

SHADE	
TRANSPARENCY	
FIRE RESISTANCE	
WATER RESISTANCE	
DARKENING	

BENEFITS

SUN PROTECTION	
WIND PROTECTION	
SNOW PROTECTION	
RAIN PROTECTION	

WIND RESISTANCE CLASS EN13561

CLASS 1	
CLASS 2	
CLASS 3	
CLASS 4	



EN: 268520

2026/03

© STOBAG – subject to change without prior notice.

Making living spaces
more valuable together.

stobag.com