



S T O B A G

Better Living Spaces  
Product Portfolio

# Contents

Preface	2
STOBAG	4
Product Introduction	10
Windows & Façade	12
Balcony & Terrace	24
Pergolas & Pavilions	44
Conservatories	66
Fabric & Frame Collection	76
Automation & Control	80
Contact & Locations	84
Key	86

A STOBAG shade solution transforms your backyard into a sheltered outdoor living space – for more light, more style and more time with the important people in your life.



Dear Customers

Outdoor living has long been more than just a trend – it's a lifestyle statement. More and more people are choosing to invest in their backyards, creating outdoor spaces that feel like an extension of the home. Our products for these spaces are not just functional solutions; they are a continuation of a building's architecture – with cubic forms, slender lines and perfect integration.

Whether as a freestanding island in the yard or mounted to the façade – a STOBAG patio shade solution creates spaces that can be used all year round. They protect outdoor furniture and kitchens, allow daylight to flood into the house, and offer outstanding flexibility, comfort and convenience, creating a cozy, inviting space.

Our vision is to create inspiring, sheltered spaces based on sophisticated solutions and Swiss precision. STOBAG stands for quality, design and innovation – and for the conviction that architecture and nature can exist in perfect harmony. It's not just about products – it's about creating shared living spaces that connect people, ideas and moments.

*C. Gremaud*

Leandro Gremaud  
CEO, STOBAG North America Corp.



For every aspect of life – a privacy screen for your balcony, shading for panoramic windows or glass roofs, or the perfect patio solution. You can explore every facet of our diverse product portfolio in our showrooms.

Since starting out in 1964, we have been continually developing shading and weatherproofing solutions that create a seamless link between architecture and nature.



For over 60 years, STOBAG – an acronym for “Storen Bau Gattikon” (shutter/blind construction in Gattikon) – has stood for quality, progress and a passion for making outdoor living more attractive. What was once a small workshop has evolved into a globally operating family business with 750 employees worldwide, 350 of whom work at the headquarters in Muri, Aargau.

Under the leadership of our CEO Leandro Gremaud, we are continuing the success story into the family’s third generation by combining tradition with modern technology and setting new standards in design and comfort, always with a clear aspiration: to create harmony between architecture and nature – and to develop solutions that inspire generations.



#### **Design with heritage**

For us, Swiss design means clean lines, premium quality and intelligent functionality. Innovation is in our DNA. From the revolutionary Trilliant telescopic-arm technology and modular awnings to louvered roof systems that expand the living space into the outdoors – we are continually setting new standards. With great attention to detail, we design products that not only offer protection but also provide inspiration – making your home a cozy and inviting place to stay.



### Responsible manufacturing

We manufacture our products at four locations in Switzerland, Europe and Canada – using raw materials almost exclusively sourced from long-standing European and North American partners. Here, state-of-the-art production meets precision craftsmanship – to create solutions that inspire on the strength of their design, functionality and durability. Sustainability is at the heart of what we do: short supply chains, carefully chosen materials, robust designs, reparability and recyclability.



### Strong partnerships

We are committed to delivering exceptional service and expert guidance you can rely on – with a personal touch. We work with over 500 specialist partners in Switzerland and more than 1,000 worldwide – so we are always close to our customers and able to provide personalised advice and support. We take pride in nurturing long-term partnerships founded on trust, some of which have lasted for generations.



### Every product a one-off

Our custom shading solutions are as unique as the way you choose to live outdoors. We offer a wide range of fully customised models, colours and comfort options that blend in harmoniously with any surroundings. Robust materials and precise workmanship ensure long-lasting enjoyment and sustainable use. Our shading solutions are perfectly tailored to your needs and your style, offering you protection and comfort for many years to come.



### Find inspiration

STOBAG invites you to explore new possibilities in outdoor living. Our showroom collection showcases how thoughtfully designed shading solutions can transform outdoor spaces into elegant extensions of the home. Each setting inspires comfort, beauty, and the creation of your own personal retreat.



Location: Headquarters Switzerland

We make living spaces more valuable together. STOBAG awnings transform your outdoor space into an oasis of comfort and style – perfectly matched to your patio, balcony or backyard. Our solutions combine design and functionality, creating outdoor spaces that give enduring pleasure.

### 1 Windows & façade

Vertical shading systems enhance comfort and energy efficiency by blocking direct sunlight and reducing heat gain, helping maintain a pleasant indoor climate while easing cooling demand. They provide privacy without sacrificing outward views, allowing natural light to remain. Integrated into the façade, these solutions elevate architectural expression, turning windows into refined, functional design features.

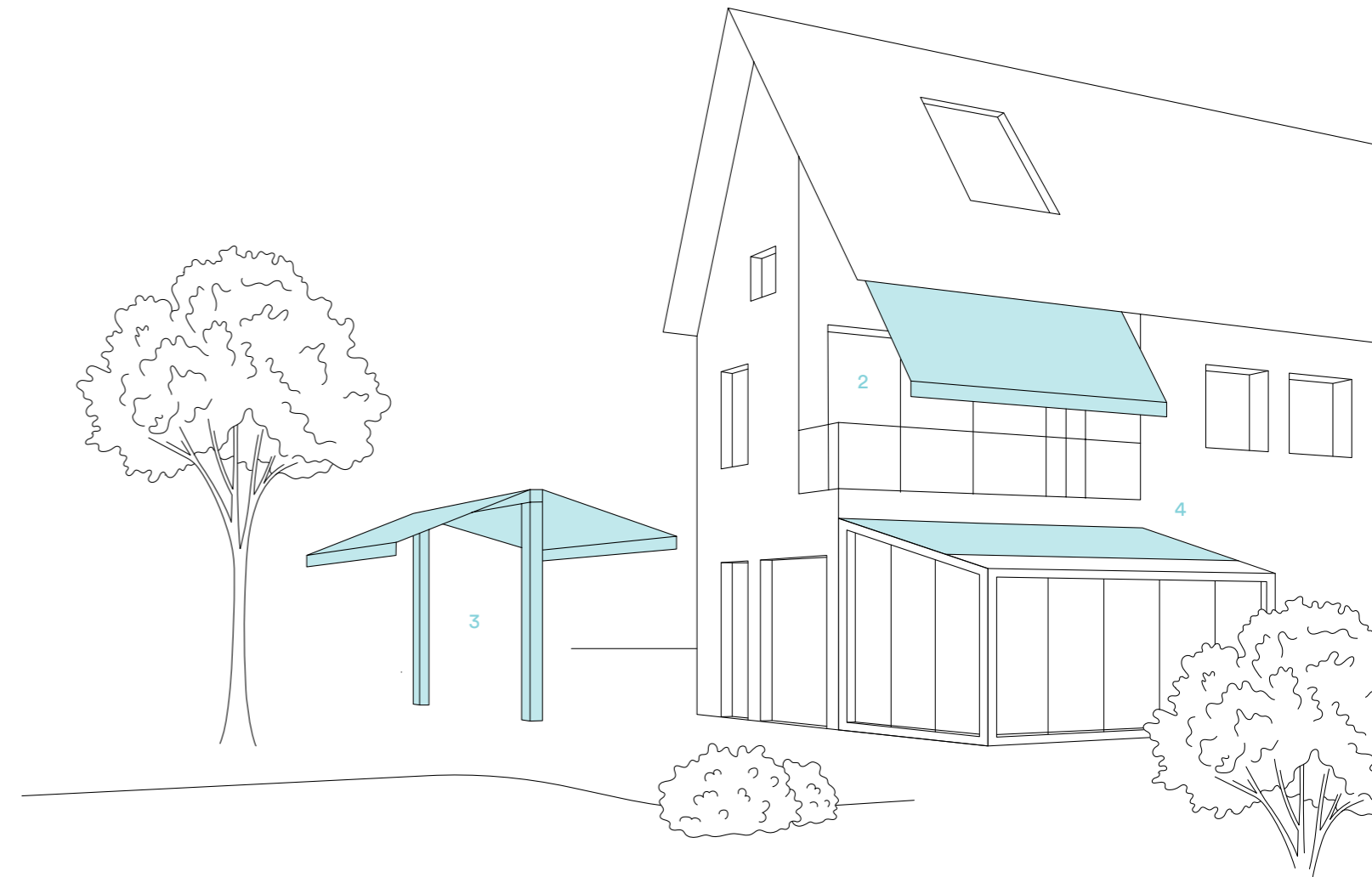
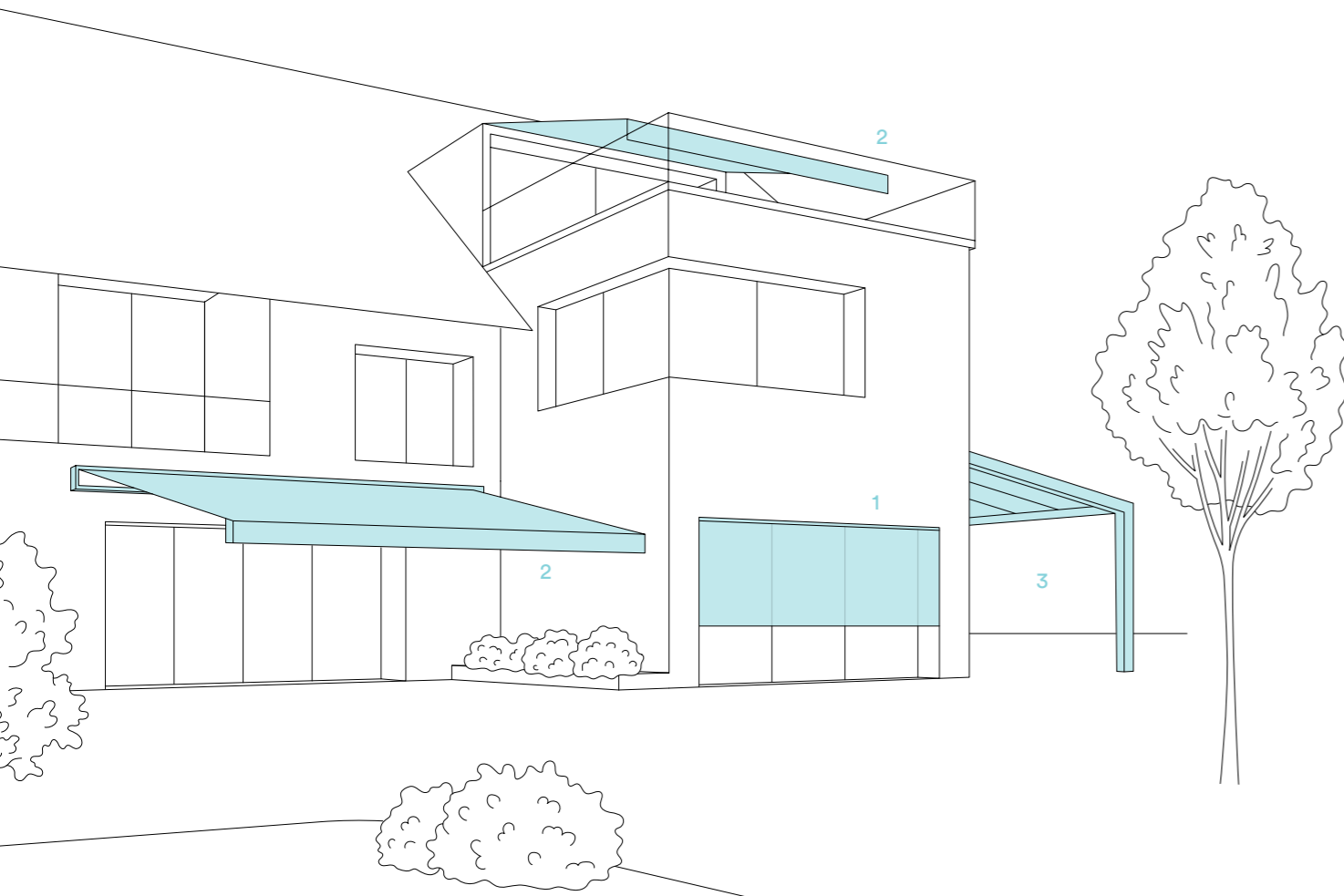

### 2 Balcony & terrace

For large outdoor spaces, we offer awnings that combine exceptional stability with refined elegance. Engineered for durability and smooth operation, they provide generous, consistent shade while enhancing comfort throughout the day. These systems help create a relaxed, inviting atmosphere — ideal for private balconies and expansive terraces. They are also perfectly suited for cafés and restaurant settings, where they contribute to a welcoming guest experience, extend usable space, and elevate the aesthetic of outdoor environments.

### 3 Pergolas & pavilions

Pergolas offer an elegant way to create a canopied garden patio. They provide reliable protection from the sun and can be harmoniously integrated into any garden. The robust aluminum pergolas and Pavilions are flexibly designed and can be configured to suit your individual needs. With a few precautions, a Pergola in the garden can even be enjoyed all year round. The sheltered space is particularly cozy during the winter months.

### 4 Conservatories

Conservatories are bright havens of retreat. Our shading systems keep your conservatory comfortable all year round, efficiently regulating the temperature so you can enjoy every season there, including the summer.



## SURAVA

Functionality and aesthetics combined.

The SURAVA product line delivers a refined shading solution engineered for seamless architectural integration. The Box version features an exceptionally slim cassette, discreetly protecting the rolled fabric while preserving a clean, elegant aesthetic. A defining feature is its cohesive design language, with consistent components such as guide systems and bottom rails. This unified approach ensures harmonious integration into the overall architecture while allowing for flexible configuration. With a broad range of options for guide systems, cassette styles, and installation types, SURAVA enables highly customized, architecturally sophisticated solutions.

**Aesthetics:** Simple fixings and selectable colour accents ensure a clean, elegant look, allowing for harmonious integration or striking contrasts. High-quality workmanship with durable materials guarantees a flawless appearance for years to come. The coordinated design and flexible configuration options open up a wide range of design possibilities.



**Zip guide**

The ZIP system delivers maximum wind stability, consistently taut fabric, and seamless sun, glare, and insect protection. The side guide rails keep the awning securely in place, even in strong winds, without any distracting rattling. It can be mounted inside or outside of the window recess.

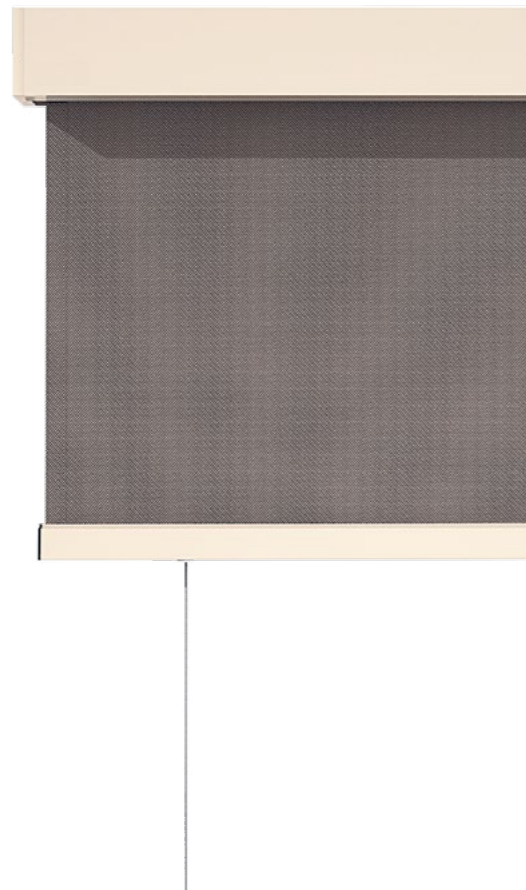

**Rod/cable guide**

An awning with rod guidance provides a discreet and stylish shading solution. Its elegant, streamlined design ensures precise line alignment while maintaining a refined architectural appearance. The system can be installed free-standing at the edge of an overhang or integrated within a window opening.





#### Seamless cover panel

The side panel without visible fasteners creates an elegant look. The premium quality cover panels feature a unique magnetic mechanism. They are available in the system colour or in an additional colour for an elegant two-tone effect.



#### Square or round cassette profile

The square cassette profile creates a clean, linear look that integrates naturally with modern façades and sharp architectural lines. The round cassette profile, on the other hand, offers a softer, more organic appearance that blends harmoniously with traditional or curved design elements. This flexibility allows the shading system to feel like a natural extension of the building rather than an added feature.



#### COMING SOON

#### Recessed cables

Recessed cable guides keep the shading system clean, safe, and unobtrusive. By positioning the cables within the structure rather than externally, the full shading width can still be used while maintaining a streamlined appearance. This approach also reduces the chance of accidental contact with the tensioned cables, creating a safer, more comfortable space for everyday use.





## VENTOSOL

Wind-stable. Sun-perfected.

VENTOSOL vertical awnings are available in various designs, shapes, and dimensions, making them ideal for a wide range of shading applications, particularly for large glass façade. They are always equipped with a cassette that fully protects all components, including the front profile. The integrated ZIP system ensures seamless shading, with the fabric and guide perfectly aligned. Engineered for performance, this system boosts energy efficiency, limits indoor heat buildup, and maintains a comfortable interior climate – ensuring outstanding sun and heat protection.

Designed for medium to large shading areas, VENTOSOL is available with square or rounded cassette profiles. The front profile remains hidden when retracted, providing a clean, streamlined look. The integrated ZIP system ensures precise fabric guidance and seamless shading.



**Seamless cover panel**

The cassette design adapts to your architecture: choose between a rounded or square shape for seamless integration and a stylish appearance.

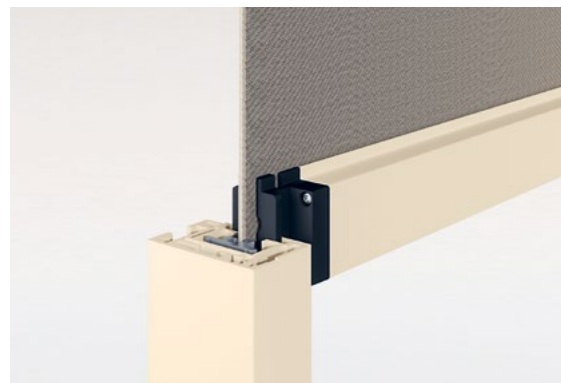

**Zip guide system**

The ZIP guide system provides maximum wind stability, consistently taut fabric tension, and seamless protection from sun, glare, or even insects. The side guide rails keep the awning securely in place, even in strong winds, without any distracting rattling.



Product	SURAVA VA2100 BOX	SURAVA VA2100 BOX ZIP
Maximum dimensions with wire rope guide (width x height)	500 x 300cm	–
Maximum dimensions with guide rail (width x height)	500 x 400cm	400 x 300cm Depending on cloth selection and projection
Wall installation	With wall bracket or clipped guide rail	Yes
Ceiling installation	With ceiling bracket or clipped guide rail	Yes
In-reveal installation	With wall or ceiling bracket	Yes
Niche installation	With wall or ceiling bracket	Yes
Self-supporting installation – clipped onto guide rail	With guide rail	Yes
Wall mounting of the guide rail	Direct screw mounting with 2-part guide via mounting clips with 1-part guide	Direct screw mounting with 2-part guide
Protective cassette	Yes	Yes
Drop profile enclosed in protective cassette when retracted	–	–
Fabric rolling direction selectable	–	–
Recessed cable guide	Yes	–
ZIP guide	See SURAVA BOX WITH ZIP	Yes
Two-part, divisible guide rail	Yes	Yes
Drive: Motor drive / manual gear box	Yes / Yes	Yes / Yes
Coupling option	Yes (maximum 3 systems)	–
Wind resistance class	Wind Class 3 49.5km/h	Wind Class 3 49.5km/h
Fabric	Acryl Soltis Horizon 86 Soltis Perform 92 Screen 5% Bug Screen	Acryl Soltis Horizon 86 Soltis Perform 92 Screen 5% Bug Screen

Product	VENTOSOL VS5200/1 + VS5200/2	VENTOSOL VM720/3
Maximum dimensions with wire rope guide (width x height)	–	–
Maximum dimensions with guide rail (width x height)	500 x 400cm	610 x 300cm
Wall installation	Yes	Yes
Ceiling installation	–	Yes. Obligatory if width is over 420cm, guide rails still required
In-reveal installation	Yes	Yes
Niche installation	Yes	Yes
Self-supporting installation – clipped onto guide rail	Yes	Up to 420cm
Wall mounting of the guide rail	Yes	Yes
Protective cassette	Yes	Yes
Drop profile enclosed in protective cassette when retracted	–	Yes
Fabric rolling direction selectable	Yes	Yes
Recessed cable guide	–	–
ZIP guide	Yes	Yes
Two-part, divisible guide rail	Yes	Yes
Drive: Motor drive / manual gear box	Yes	Motor only
Coupling option	–	–
Wind resistance class	Wind Class 3 49.5km/h	Wind Class 3 49.5km/h
Fabric	Acryl Soltis Horizon 86 Soltis Perform 92 Screen 5% Bug Screen	Soltis Horizon 86 Soltis Perform 92 Screen 5% Bug Screen

Product options are available based on your selected configuration. Contact us to create the optimal solution for your space.



Selecting the right fabric is crucial when it comes to ensuring high-quality shading. Further information can be found on page 76 or in our digital fabric finder.



## VIVO

Modular awnings for luxury outdoor living.

Expand your living room into the outdoors and savour precious moments under the open sky. VIVO adapts to your needs – be it for small balconies or large patios – impressing with its sophisticated design and compact, timeless design language. Linear surfaces and the harmonious integration of every component create a flowing overall look. Thanks to its modular design, VIVO is fully customizable and easily expandable in the future. A wide range of frame and fabric colours, patterns, and optional functions afford you maximum design freedom. VIVO is a durable, high-quality awning ready to meet your requirements – an investment in comfort, protection and the value of your living space.

VIVO awnings are durable and modern. Because needs change over time, VIVO has been designed as a modular and expandable system. With VIVO, you're investing not only in comfort and protection, but also in the value of your living space.



**Elegant protection for fabric and facade**  
An optionally available top board reliably protects the fabric from rain, sun and dirt, while a wall connection profile prevents dirt streaks on the facade. At the same time, the top board lends the construction an elegant touch and ensures a harmonious overall look – functional yet stylish.



**Protective sleeve – ingenious protection with a slimline look**  
The protective sleeve reliably shields the retracted fabric from weather effects and dirt, while built-in drainage channels direct rainwater away from the awning. The result is a clean look with durable functionality – and a design that blends seamlessly into any architecture.

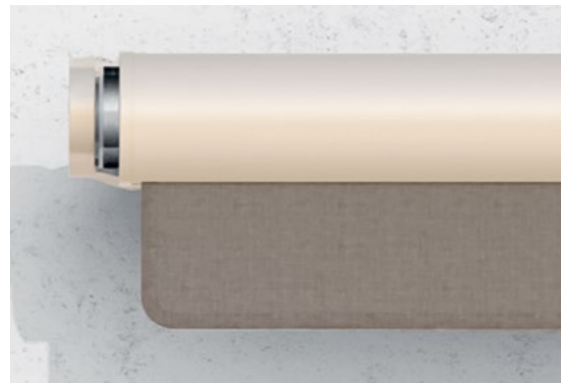

**Valance – a stylish detail with a big impact**  
The valance elegantly conceals the structure, protects the arms from weather effects and allows a lower awning inclination angle, affording you a better view and more clearance – not to mention extra protection from the low-lying sun.



The optional **drop-down valance** shields you from low-lying sun and breezes whenever you need it. Depending on the fabric you choose – transparent or opaque – you can enjoy pleasant light with an unobstructed view of the outside or maximum privacy. For more protection and a greater feeling of security.

 All the technical details are listed for you on page 42

# Trilliant telescopic arms – exclusive technology for perfect fabric tension.

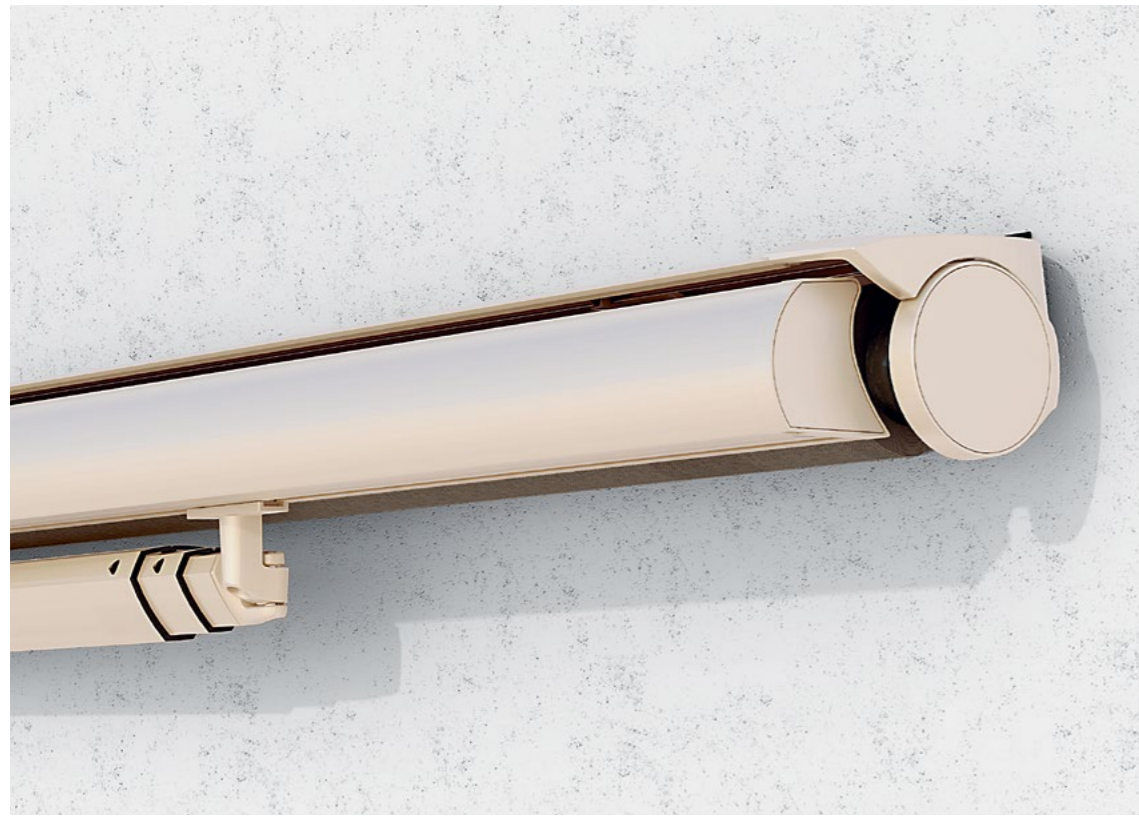

VIVO with Trilliant telescopic arms is an innovation in the awning market. A world first, these arms not only offer exceptional stability, but also serve as aesthetic, design-defining elements for high-end architecture. Thanks to their unique design, the

Trilliant telescopic arms have a slender profile and, when combined with Back-Impulse Technology, ensure excellent fabric tension. The linear movements of the Trilliant telescopic arms make extending the VIVO awning a moment to enjoy.



VIVO animation  
Be inspired.



DESIGN  
AWARD  
2024



reddot winner 2024





## SELECT

Versatile sun protection designed for any space.

The SELECT awning is suitable for both small and large spaces. Its mounting-bar construction allows flexible installation on the wall, ceiling or rafters. Options include a drop-down valence for extra privacy and glare protection, as well as a top board that shields both the fabric and the mechanism from the elements. With a SELECT awning, you are choosing functional sun protection with a range of optional features – simple, versatile and built to last.

The SELECT awning combines versatility with comfort. Designed to fit almost any space, it offers flexible installation options. With the innovative Ombramatic technology, it creates personalized sun protection, greater privacy, and an inviting, comfortable ambiance.



**Ombramatic – flexible adjustment of the awning inclination angle**

The sun's position – and therefore also the shade – changes throughout the course of the year. The Ombramatic function lets you alter the slope on your awning to any angle up to 60°, giving you optimum protection from the sun and glare all year round. A hand crank allows easy adjustment – a simple and convenient solution.

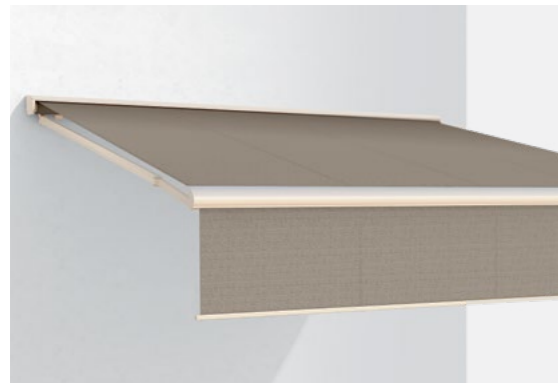

**Drop-down valance**

Designed for comfort, this drop valance shields you from low sun and adds a warm, cozy touch. It can be flexibly lowered to provide protection from glare and breezes. Depending on the fabric you choose – transparent or opaque – you can enjoy either an unobstructed view of the outside in pleasant light or maximum privacy. This keeps your outdoor space open yet protected – for relaxing moments at any time of day.



**Cross-over folding arms**

When you need more projection than width, thanks to a special design with crossed articulated arms, shade can be reliably provided for narrow roof patios and window niches.



 All the technical details are listed for you on page 42



## CASABOX

The compact box awning for small to medium-sized areas.

For those who value both form and function. Round or square – the CASABOX offers two stylish options to perfectly complement your architecture. The closed cassette reliably shields the fabric from the weather, ensuring lasting quality and minimising maintenance. An optional wall connection profile creates a seamless link to the facade – designed to prevent dirt streaks, protect the building structure and maintain a pristine look. The cassette fully encases the retracted awning – for a tidy look and peace of mind. Ideal for small to medium-sized patio areas, garden patios or balconies.

## Coverage – whatever your inclination



Designed for both performance and aesthetic versatility, the awning can be inversely inclined up to 90 degrees—depending on the mounting configuration—to achieve optimal sun protection throughout the day. Available in square or round profiles, it adapts seamlessly to its architectural context: the square cassette offers clean, precise lines that complement modern façades, while

the rounded profile introduces a softer, more elegant expression suited to classic or curved designs. Optional LED lighting extends usability into the evening with energy-efficient, low-maintenance illumination, while bracket covers discreetly conceal mounting hardware and protect against the elements, ensuring a refined, cohesive appearance.



 All the technical details are listed for you on page 42



## TENDABOX

Round or square design – comfort  
for any architectural style.

The TENDABOX is an elegant box awning for medium- to large-sized patios and garden patios. When the awning is closed, the cassette keeps the fabric and mechanism fully shielded from the elements, preserving its pristine appearance and ensuring long-lasting performance. With a choice of square or round designs, the TENDABOX stylishly adapts to different tastes and architectural styles. The drop-down valance, which can be optionally integrated, offers privacy and additional glare protection when the sun is low.

TENDABOX is the stylish solution for medium- to large-sized patios and garden patios. Measuring up to 6.5 metres in width, with a projection of up to 4 metres, it provides generous shade. The optional drop valance offers reliable protection from low-lying sun while also enhancing privacy.



**Square or round design**

A square awning profile impresses with its precise design language and blends in perfectly with modern façades, bringing structure to the outdoor space. A round profile is ideal for buildings with curved design language or classic architecture and lends TENDABOX an elegant, soft look.

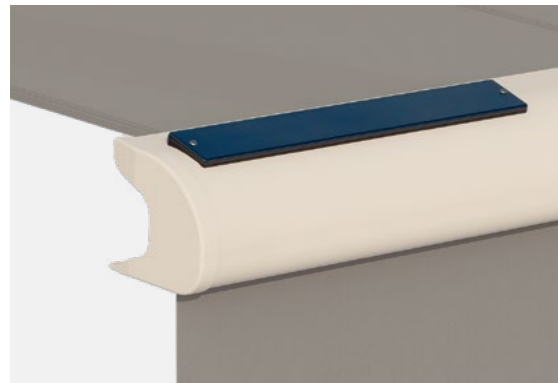

**COMING SOON**

**Motorized lowerable drop-down valance**

This solar-powered drop-down valance mechanism enhances the drop-down valance option with touch-of-a button convenience.



**LED lighting**

LED lighting delivers energy-efficient, low-maintenance illumination without compromising the awning's clean, architectural lines.

**Bracket cover**

Designed to conceal mounting hardware while protecting against the elements and maintaining a polished, modern look, the high-quality bracket cover delivers function and form.



**Drop-down valance**

Ideal for transitional months when the sun sits low, the optional drop-down valance helps block glare and increase privacy, creating a more sheltered outdoor space. Available with the rounded cassette profile.

 All the technical details are listed for you on page 42

Product	VIVO S6800/P	SELECT S813X
Open awnings	Yes	Yes
Box awnings	Semi, with S6800/P, up to 600cm wide	-
Award-winning design	Yes	-
Maximum dimensions (width x projection)	700 x 400cm	700 x 350cm
Installation on wall	Yes	Yes
Installation under ceiling	Yes	Yes
Installation on rafters	Yes	Yes
Installation in alcove	-	-
Maximum slope	0°-60°	0°-60°
Manual slope adjustment	-	Yes on S8135 Only
Folding arms	-	Yes
Telescopic arms	Yes	-
Semi-cassette (fabric protection)	Yes (up to max. 600cm width)	-
Top board	Yes	Yes
Valance	Yes	Yes
Light at front	Coming soon	-
Light at rear	-	-
Drop-down valance (manual)	Yes (up to max. 700cm width)	Yes
Robust Tenara sewing thread as standard	Yes	Yes
Motor drive	Yes	Yes, CMO also available
Manual gearbox	-	Yes
Comfort control (handheld transmitter, weather sensors, smart home)	Yes	Yes
Wind resistance class	Wind Class 2 38.5km/h	Wind Class 2 38.5km/h
Fabric	Acryl Water Fire  Lowerable Drop-Down Valance: Acryl Soltis Horizon 86 Soltis Perform 92 Screen 5% Bug Screen Water Fire	Acryl Water Fire

Product options are available based on your selected configuration. Contact us to create the optimal solution for your space.

Product	CASABOX BX2000	TENDABOX BX3000
Open awnings	-	-
Box awnings	Yes	Yes
Award-winning design	-	-
Maximum dimensions (width x projection)	550 x 250cm / 500 x 300cm	650 x 350cm / 600 x 400cm
Installation on wall	Yes	Yes
Installation under ceiling	Yes	Yes
Installation on rafters	Yes	Yes
Installation in alcove	Yes	Yes
Maximum slope	5°-90°	0°-85°
Manual slope adjustment	-	-
Folding arms	Yes	Yes
Telescopic arms	-	-
Semi-cassette (fabric protection)	-	-
Top board	Yes	Yes
Valance	-	-
Light at front	-	-
Light at rear	Yes	Yes
Drop-down valance (manual)	-	Yes
Robust Tenara sewing thread as standard	Yes	Yes
Motor drive	Yes	Yes
Manual gearbox	Yes	Yes
Comfort control (handheld transmitter, weather sensors, smart home)	Yes	Yes
Wind resistance class	Wind Class 2 38.5km/h	Wind Class 2 38.5km/h
Fabric	Acryl Soltis 96 Water Fire	Acryl Soltis 96 Water Fire  Lowerable Drop-Down Valance: Acryl Soltis Horizon 86 Soltis Perform 92 Screen 5% Water Fire



Selecting the right fabric is crucial when it comes to ensuring high-quality shading. Further information can be found on page 76 or in our digital fabric finder.



## PERGOLINO

The perfect fit.

PERGOLINO transforms your patio into a favourite spot no matter the weather. This façade-mounted pergola awning offers reliable protection while creating a comfortable, sheltered space. Individually re-positionable supports provide maximum flexibility and stability, even in changing weather conditions. Designed to maintain its form and appearance, the automatic fabric tensioning prevents water pooling, ensuring the fabric stays taut and performs reliably in the rain. Optional lighting creates the perfect atmosphere for any evening.

**Flexible installation. Just how you like it**

Thanks to its versatile mounting options, PERGOLINO can be attached either to wall or ceiling, using specially-developed ceiling brackets for a secure and stable installation. Special highlights include the repositionable supports, plus guide rails with adjustable width and depth. Even the fixing brackets can be flexibly positioned for maximum design freedom and seamless appearance.

For ground fastening, there is a base plate, which guarantees optimum stability. Even when the wind picks up, you can rely on PERGOLINO standing firm, thanks to its high wind stability – for carefree hours in the open air.



# STOBLOCK takes care of the adjustments – leaving you to relax



The PERGOLINO pergola awning is both eye-catching and inviting. Its STOBLOCK system automatically keeps the fabric taut, with no need for manual readjustment – come rain, shine, or wind. This means no creases, no water pockets, and no worries. Choosing the right slope and fabric keeps rainwater drainage under control, while the fabric stays flawlessly smooth day after day. STOBLOCK ensures effortless comfort and safety, leaving you to relax and enjoy your time outdoors.



**STOBLOCK System**  
See how it works.



Enjoy your patio well into the evening with optional LED lighting. The warm light creates a pleasant, inviting atmosphere while providing practical illumination for relaxing, dining, or entertaining outdoors. Designed to complement the awning, the lighting enhances both functionality and visual appeal, extending the usability of your outdoor space and adding a refined finishing touch.

 All the technical details are listed for you on page 65



## BAVONA

Controlled Light. Open Space.

Perfect harmony between technology and design – for a stylish outdoor retreat. The elegant BAVONA slat roof combines minimalist design with maximum functionality: the aluminium slats are rotatable up to 110° and allow precise control of light, shade and ventilation – depending on the time of day and how the mood takes you. Whether gentle morning light or cooling afternoon shade – BAVONA adapts flexibly, creating a bioclimatic oasis of well-being in the open air.

A wide range of installation options makes BAVONA a truly adaptable system: freestanding in the yard, mounted to a façade, integrated between buildings, or even added to existing structures. It blends seamlessly into any architectural setting, creating new possibilities for patios and atriums. Thanks to its modular design, BAVONA can be custom-configured with features such as side shades and integrated LED lighting to enhance comfort – even in windy or challenging conditions. Discreet technology, clean lines, and premium materials make BAVONA the ideal solution for refined outdoor living on penthouse terraces and garden patios

# Light, air and freedom – any way you like

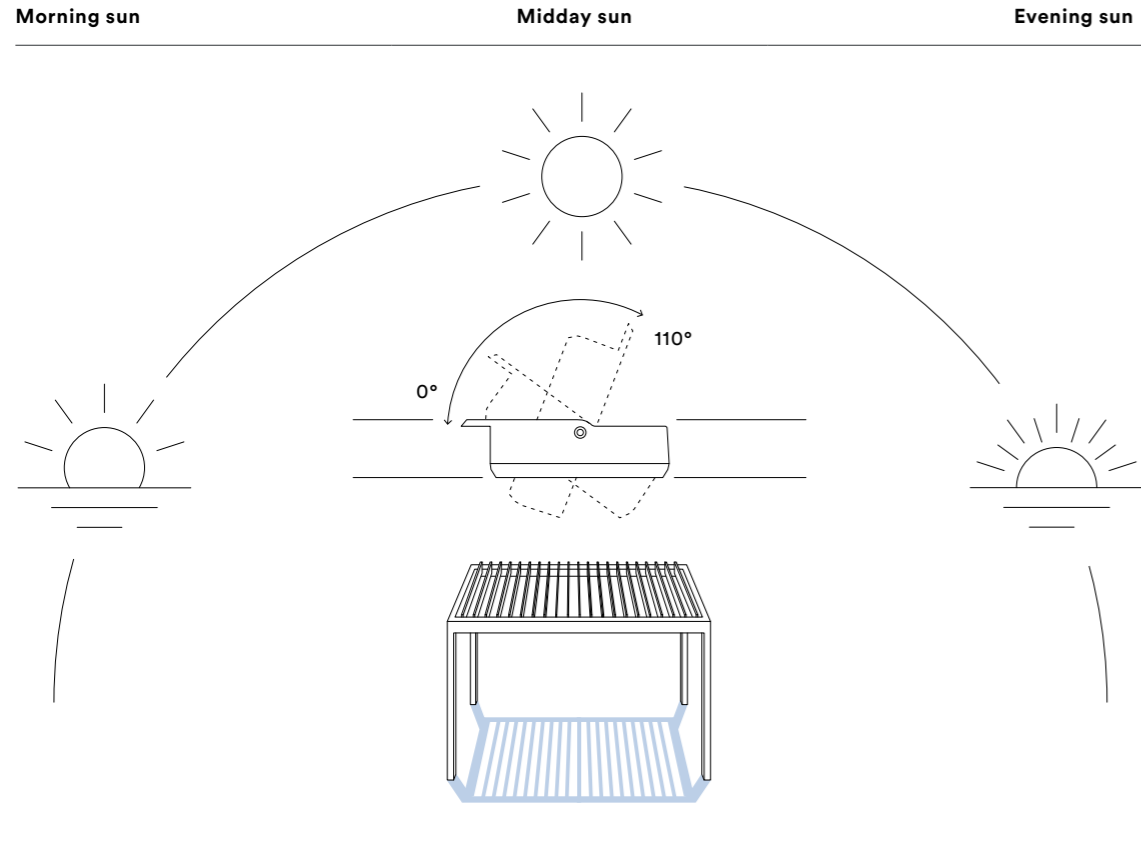

At the heart of the patio canopy are the 110° adjustable aluminium slats. This outstanding flexibility allows precise control throughout the day. Gentle morning sunlight, pleasant midday shade, and a clear view of the evening sky – the slats can adapt to any mood and any weather. When closed, they provide reliable shelter from the rain. When open, they allow natural air circulation: warm air rises and escapes, while cooler air flows in, creating a

pleasant bioclimate. The 110° adjustability also enhances comfort and convenience; it allows precise light control, prevents hard shade, and ensures a friendly, light ambience – even in strong sunlight. Therefore, your outdoor space remains a great place to be, even in hot weather, and a favourite spot at any time of day – an ideal opportunity to start the garden season early and extend it into the golden late autumn.

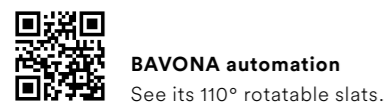

# A multitude of installation options for any architecture

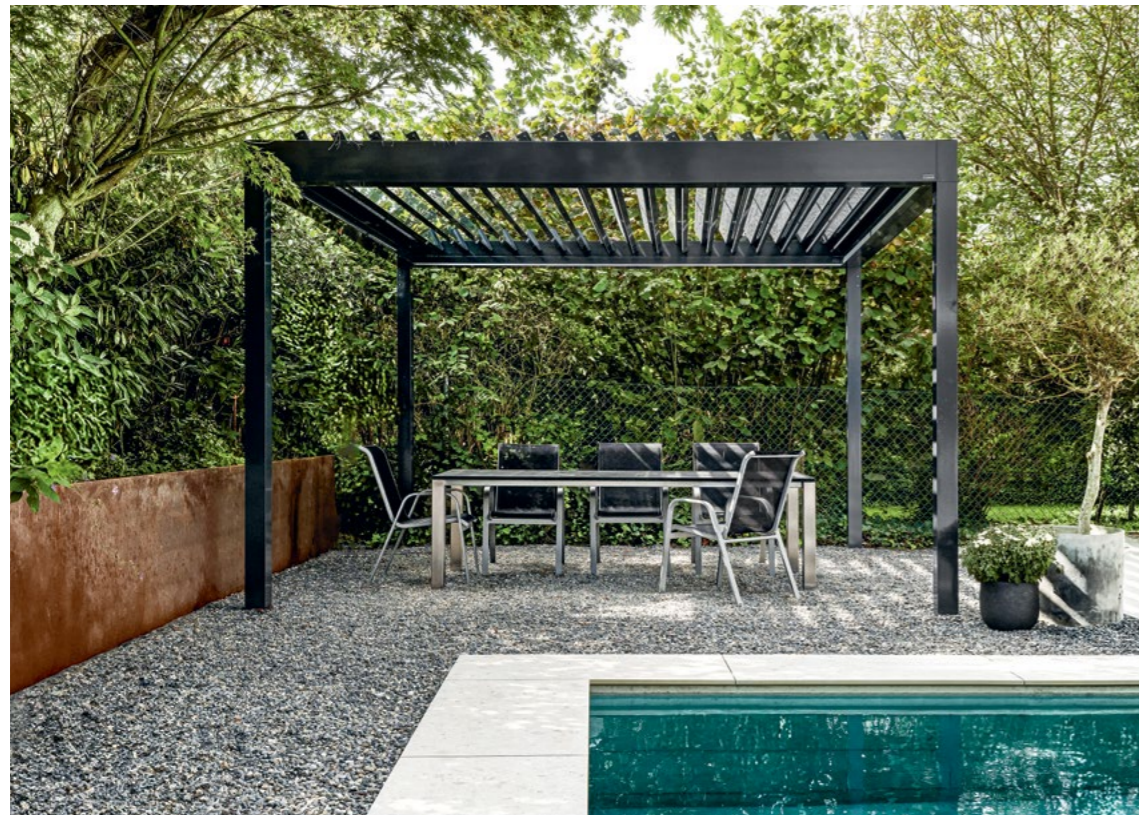

Design your favourite outdoor spot just how you like it: whether an urban inner courtyard, spacious garden or elegant rooftop terrace – BAVONA blends in harmoniously with any architecture. Installation on a wall creates a flowing link between indoors and outdoors, transforming your patio into an extension of your living space. The freestanding

version gives you maximum freedom – a private retreat surrounded by greenery. Recessed installations ensure particularly discreet solutions – seamlessly integrated for clean lines and stylish elegance. BAVONA transforms your outdoor space into an oasis of well-being – regardless of location and architecture.

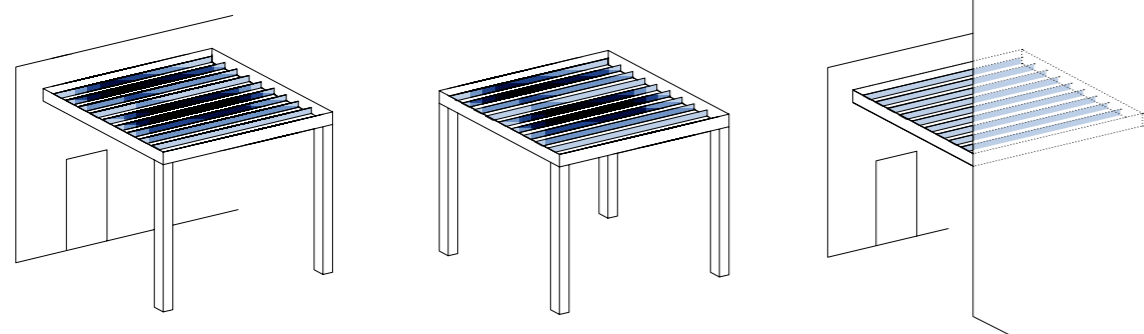

## Proven strength, authentic quality

With an average size of 4 × 6 metres, BAVONA features a stable aluminium construction with a snow load of up to 120 kg/m<sup>2</sup> – equivalent to the weight of a fully grown grizzly bear. It stands for quality you can feel and safety you can count on. BAVONA is durable, elegant and uncompromisingly robust.

## Two-tone installation



### Contrasting light-coloured slats

The two-tone design breathes new life into the design of modern al fresco solutions. Choosing slats that are lighter in colour than the main frame – such as elegant white or grey slats with an anthracite frame – adds character and style.

### More light. Less heat

Light-coloured slats reflect daylight and create a welcoming ambience – even when the shades are closed. Lower heat absorption ensures a pleasant temperature without the need for additional cooling.



**Atmospheric light**

Discreet dimmable Neutral White lighting creates a refined, inviting ambiance, bringing your outdoor space into focus from dusk into the evening. Fully integrated LED strips are seamlessly incorporated into the slats and structural frame, delivering a clean, high-end aesthetic with no visible cables or added elements. The result is lighting that blends effortlessly into the design, enhancing the installation's architectural clarity.





## BOXMOBIL

Two cassettes. One inspiring system.

Generous shade. Whether on the penthouse terrace, in the yard or on the patio – BOXMOBIL provides reliable sun protection in medium-sized to large areas. Two box awnings are mounted on a stable steel support structure – with no obstructive centre support, leaving the space beneath fully usable. There are two designs available: one with a square front rail, and one with a round front rail. The freestanding double awning is easy to operate using a crank handle, making it ideal for flexible usage. For even greater convenience, there is an optional motorized drive available, which extends the two awnings either simultaneously or separately at the push of a button. BOXMOBIL really comes into its own on rooftop terraces with limited structural options or when planning is done retrospectively.

One thing you can rely on – stability. BOXMOBIL stands firm in every situation. The robust supports are discreetly anchored in the ground using recessed ground sleeves, ensuring reliable stability even in wind or adverse weather.

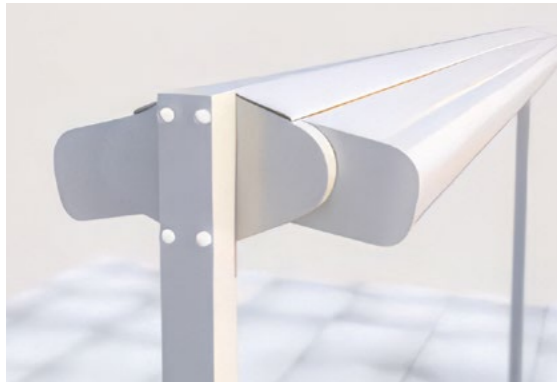

**Round box**

The elegant round box provides premium protection for the rolled-up fabric, keeping it clean and shielded from the elements.

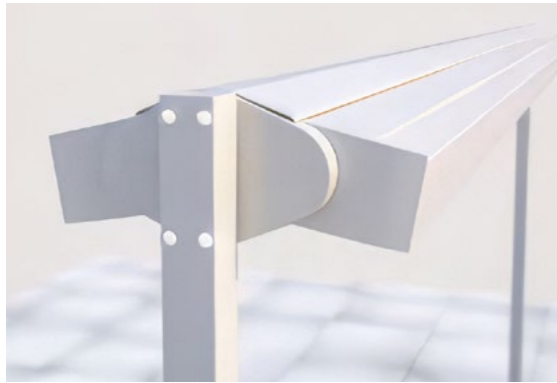

**Square box**

The angular box design also provides optimum protection for the awning with a clean, modern design.



**Drop-down valance – more than just shade**

As the sun dips low and bathes the day in golden light, the drop-down valance turns every outdoor moment into pure relaxation. With its glare protection and convenient crank handle, the drop-down valance provides reliable protection from sunlight. Thanks to the floating system, the fabric rolls up exceptionally evenly. Choose either opaque acrylic fabric up to 110cm or translucent fabric up to 160cm – for more privacy and a feeling of freedom.





 All the technical details are listed for you on page 65

Product	PERGOLINO P3500	BAVONA TP6500	BOXMOBIL OS7000
Maximum dimensions (width x projection)	700 x 600cm with 3 guide rails for widths of 600cm+ and projections of 450cm+, or all units over 650cm projection	450 x 610cm	662 x 700cm
Maximum installation height	Front max of 300cm	320cm (297cm support + 23cm roof)	303cm
Slope	0°–35° Use in rain at least 8°	Construction 0° Adjustable slats open 0–110°	5°–35°
Installation on wall	Yes	Yes	One-sided
Installation under ceiling	Yes	Yes	–
In-reveal installation	–	Depending on installation situation, – Yes / Ensure accessibility to motors	–
Freestanding installation	–	Yes	Yes
Installation on existing substructure	Yes	–	–
Side/front shades	–	Yes	Drop-down valance as front shading
Linking of installations	Yes	–	Yes
Integrated water drainage system	–	Yes	–
Lighting	Yes	Yes	Yes
Motor drive	Yes	Yes	Yes. Gear only available up to a maximum width of 612cm drop-down valance only with the gearbox
Wind resistance class	Wind Class 3 49.5km/h	Vertical awnings: 49.5km/h When slats closed: up to 150km/h	Wind Class 2 38.5km/h
Fabric	Acryl Water Fire	Side/front shades: Soltis Horizon 86 Soltis Perform 92 Screen 5% Bug Screen	Acryl Water Fire  Drop-down valance: Acryl Soltis Horizon 86 Soltis Perform 92 Screen 5% Bug Screen Water Fire

Product options are available based on your selected configuration. Contact us to create the optimal solution for your space.



Selecting the right fabric is crucial when it comes to ensuring high-quality shading. Further information can be found on page 76 or in our digital fabric finder.



## TARGA

Out of the ordinary.

TARGA offers optimum adaptability and harmonious integration – for classic or more unusual roof shapes. It provides effective sun protection for large and complex glass surfaces. The guide rails are highly practical as they can be moved inwards, making an ideal solution possible – even for non-standard shapes. Cutting-edge technology keeps the fabric perfectly taut, creating a sleek, harmonious look – even on installations up to 7 metres wide.

The self-supporting structure with adjustable guide rails provides sun protection over a wide area – even when the sun is low.



**Engineered for strength –  
designed for flexibility**

The TARGA boasts an impressive self-supporting structure; the sleek box provides sturdy support without the need for mounting on the facade, with a clean side finish and a cleverly concealed electric plug. Enjoy extensive sun protection with uninterrupted shading over a width of up to 7 metres.

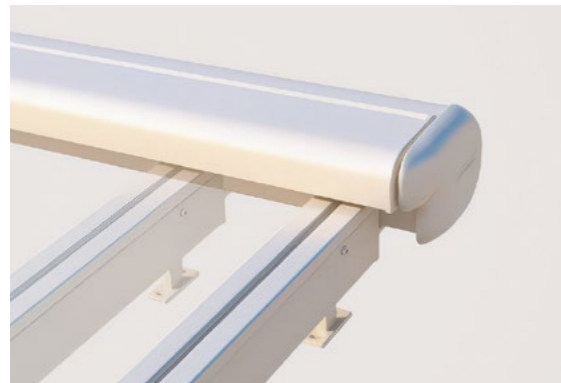

**As flexible as your conservatory**

The guide rails can be adjusted inward continuously by up to 100cm, offering maximum flexibility for bespoke conservatory designs and individual requirements.



 All the technical details are listed for you on page 75



## AIROMATIC

Compact, slender and reliable.

The AIROMATIC line is ideal for small to medium-sized conservatories up to 33 m<sup>2</sup>; suitable for most conservatory designs and offers the right sun protection for almost any situation. The slim structure blends in harmoniously with the overall appearance of your home and impresses with its discreet look, simple installation, and reliable protection from heat and intense sunlight. For relaxing hours in your conservatory at home – any way you like.

Be it a conservatory or a large skylight, having sun protection on the outside creates a comfortable indoor climate and welcoming light. Your favourite spot remains cool and glare-free, even on hot days.



**Perfect for large areas**

Shade conservatories up to 33 m<sup>2</sup>. The self-supporting structure ensures stability and a slimline look. Integrated gas struts guarantee uniform fabric tension for perfect sun protection. The guide rail allows seamless installation, while a range of brackets ensures maximum flexibility – for a design that is both functional and sleek. A built-in motor makes for convenient operation – at the touch of a button.

**Inspiring colours. Noticeable comfort**

Choose from a wide range of high-quality fabric colours and textiles offering high UV protection as well as outstanding resistance to sunlight and fading. And enjoy first-class sun protection while giving your outdoor space a personal touch.



 All the technical details are listed for you on page 75



Product	TARGA PS6000	AIROMATIC PS4500
Maximum dimensions (width x projection)	700 x 700cm	550 x 600cm
Slope	3–35°	0–90°
In-reveal installation	–	–
Installation on existing substructure	Yes	Yes
Drive system: Motor drive / gearbox	Yes / –	Yes / –
Variable guide positions	Yes	–
ZIP system	–	–
Wind resistance class	Wind Class 3 49.5km/hr	Wind Class 3 49.5km/hr
Fabric	Acryl Water Fire	Acryl Water Fire

Product options are available based on your selected configuration.  
Contact us to create the optimal solution for your space.



Selecting the right fabric is crucial when it comes to ensuring high-quality shading. Further information can be found on page 76 or in our digital fabric finder.

# Fabric collection

## Material selection

Selecting the right fabric is crucial when it comes to ensuring high-quality shading. Colours, textures and material properties all have a bearing on aesthetics, comfort and functionality. All our fabrics provide high UV and heat protection. They can also be translucent, water-resistant, fire-resistant or darkened, depending on the material and coating – so there’s an ideal solution to meet any need and any design requirements.

## Light and heat protection

Targeted regulation of daylight, heat and transparency for windows with ZIP vertical awnings.

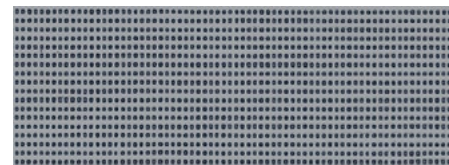

### Soltis Horizon 86

Unobstructed views of the outside thanks to maximum transparency. With an opening factor of 14%, the fabric lets in natural light while blocking up to 93% of the heat.

### Soltis Perform 92

Thanks to its low opening factor of 4%, the fabric blocks out lots of light and almost all the heat. Blocks up to 97% of the heat and provides outstanding sun and glare protection.

### Screen 5%

Coated fibreglass yarns for lasting strength and fabric stability. With attractive woven texture and two-tone look. The opening factor of 5% ensures transparency.

## Sun protection and weather resistance

Effective protection from the sun and weather for awnings and vertical awnings on balconies and patios.

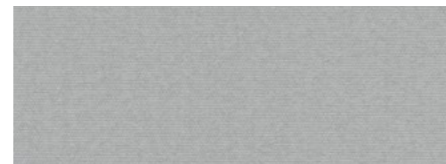
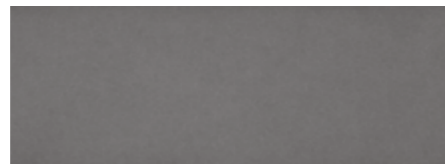

### Acrylic

Offers outstanding protection from UV radiation. High-quality acrylic fabrics retain their colour for a long time. Available in solid colours, or with narrow, wide or multicoloured stripes, or in “Brilliant” design – the exclusive premium version.

### Water\*

Special waterproof acrylic fabric as an all-weather solution. A water- and stain-resistant outer coating protects the fabric.

### Fire\*

Flame-retardant design with a water-repellent coating for weather resistance.



Explore our wide range of fabrics using the online fabric finder

\* Available by special order

## Colour selection







Choose from over 100 fabric colours across our fabric collections. Simply connect with your STOBAG representative partner to review our collection kit and ensure the optimal selection for your project – delivering the ideal solution for any need and design vision.

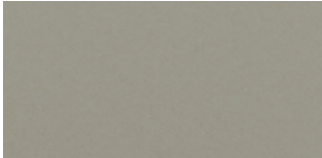
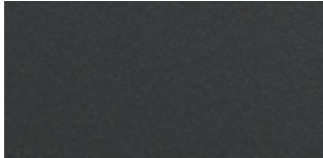
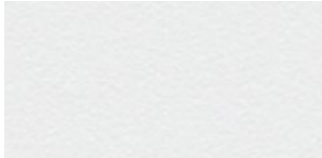

# Frame collection

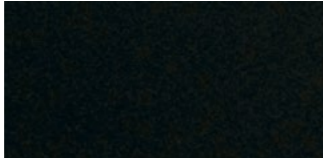
Thanks to a wide choice of colours and surfaces, the frames blend in perfectly with the overall design – matched to the fabric and the surroundings. With 12 LIFESTYLE colours, 8 CLASSIC colours and a multitude of RAINBOW colours, the wide range has the ideal solution to suit any taste. Our surface structure varies depending on the colour shade – from shiny to matte to finely structured surfaces. All profiles and components have a high-quality powder coating and offer durable weather protection.

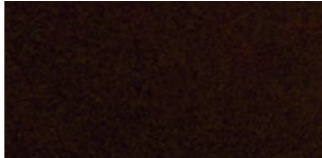
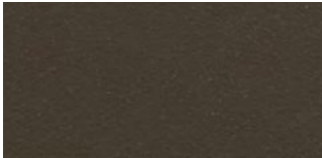
## LIFESTYLE colours

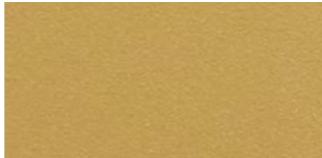
			
<b>L12 – Classic 31</b> SILK GREY	<b>L22 – Classic 37</b> UMBRA GREY	<b>L40 – RAL 9016</b> TRAFFIC WHITE	<b>L42 – RAL 9006</b> WHITE ALUMINIUM
			
<b>L24 – RAL 9005</b> JET BLACK	<b>L20 – Classic 35</b> BLACK BROWN	<b>L48 – RAL 7016</b> ANTHRACITE GREY	<b>L18 – Classic 34</b> MOCHA BROWN
			
<b>L52</b> BROWN GREY	<b>L14 – Classic 32</b> CONSTRUCTION SILVER	<b>L58</b> CUPRUM SPIN	<b>L54</b> GOLD SAND

## CLASSIC colours

			
<b>C10 – RAL 9016</b> TRAFFIC WHITE	<b>C12 – RAL 9010</b> PURE WHITE	<b>C28 – RAL 9006</b> WHITE ALUMINIUM	<b>C44 – RAL 9007</b> BEIGE
			
<b>C46</b> BRONZE	<b>C34 – DB703</b> FERRITE	<b>C50 – RAL 7016</b> ANTHRACITE GREY	<b>C52 – RAL 9005</b> JET BLACK

## RAINBOW Colours

Choose any colour under the Rainbow using the RAL colour matching system. These bespoke Rainbow colours feature a smooth, satin-like finish. Rainbow colours allow you to perfectly coordinate your frame with our fabrics and surrounding architectural setting. To learn more, contact us.



**Important information:** The colour fields shown are not binding in terms of shade and sheen; variations from the original colours may arise from the printing process and cannot be ruled out due to varying production processes and pigmentation. The decisive factor for the production and control of RAL and NCS colours is defined exclusively by the individual lists (eg: RAL840-HR/RAL841-gL) or NCS standards.



## Comfort at the push of a button

It's this easy to control your home.

More freedom, more quality of life – electric control lets you enjoy even more comfort and convenience in your home. STOBAG offers high-quality solutions – from practical handheld transmitters to seamless integration into popular smart-home systems – for sun, light and weather protection that adapts to your daily needs and the weather. You can control everything conveniently using a handheld transmitter or an app on your smartphone.

Choose between classic control and smart solutions that adapt to your daily needs and the weather.



#### Handheld transmitter

Simple, clear and convenient. Thanks to up to 16 channels, you can control several functions or products using a single transmitter – to meet all your needs.

#### Sensors

Sensors detect wind, sun and rain, and control your system automatically. This keeps your sun protection safe, leaving you to enjoy a carefree day. In strong winds, the awnings retract in plenty of time to protect the installation. In intense sunlight, they activate the sun protection, preventing your home from overheating.

#### Smart home

STOBAG gets you ready for a smart home. You can control everything centrally using the TaHoma app – conveniently on your smartphone or tablet or by voice command, whether you're relaxing at home on the couch or out and about. This lets you keep an eye on all the functions and save custom scenarios such as "evening light" or "sun protection active". Your system reacts automatically to changes in the weather, enhances comfort and convenience, and prolongs the life of your products. At the same time, energy efficiency increases: the sun protection closes in summer to keep heat out, while the sun's warmth is used in winter to create a pleasant indoor climate. For complex living concepts, there are also interfaces to wired control systems such as KNX and DALI.

#### Retrofittable as and when you need

Needs change – and our products change with them. Almost all of our installations can be subsequently expanded or modernised. You can simply switch your existing solution from cable to radio control, integrate it into a smart home or add sensors. It's also possible to incorporate additional products at any time. Your home therefore remains flexible and adapts to your needs – now and in the future.



Whether for awnings, patio roofs or vertical shading – everything can be operated and controlled centrally. Open and close awnings with a single click, adjust or dim the light how you like, or change the colour temperature. Even the drop valance can be extended and retracted with ease, the slats on slat roofs rotate into any desired position, and side shades react flexibly to your needs.

# Bespoke advice for your project

Experience the variety of our sun and weather protection solutions live – in one of our STOBAG showrooms. Our experts provide comprehensive advice on patio roofs, shading solutions, and the right fabric selection.



Book an appointment at one of our showrooms:  
[www.stobag.com/goto/showroom](http://www.stobag.com/goto/showroom)

Would you like a consultation at your home? Our experienced specialists will advise you personally and take care of planning and installation.



Find a specialist near you:  
[www.stobag.com/goto/dealer-search](http://www.stobag.com/goto/dealer-search)



**STOBAG**  
North America Corp.  
1445 Norjohn Ct Unit 7  
Burlington, ON L7L OE6  
Canada

**STOBAG AG**  
Europe  
Pilatusring 1  
5630 Muri  
Switzerland

**STOBAG SA**  
Switzerland  
En Budron H / 18  
1052 Le Mont-sur-Lausanne  
Switzerland

**STOBAG**  
Österreich GmbH  
Radlberger Hauptstrasse 100  
3105 St. Pölten-Unterradlberg  
Austria

# Key

## SURFACE SHINE

DEEP MATTE	
MATTE	
SILK GLOSS	

## SURFACE STRUCTURE

SMOOTH	
FINE STRUCTURE	

## SURFACE EFFECT

HOMOGENEITY	
PEARL MICA	



# Manufacturer's warranty



Full warranty terms:  
[www.stobag.com/ca/en/warranty-policy](http://www.stobag.com/ca/en/warranty-policy)



Making living spaces  
more valuable together

[stobag.com](https://stobag.com)